



Australian Government
Australian Transport Safety Bureau

Engine room fire on board the bulk carrier *Marigold*

Port Hedland, Western Australia | 13 July 2014



Investigation

ATSB Transport Safety Report
Marine Occurrence Investigation
312-MO-2014-008
Final – 20 April 2016

Cover photo: Australian Transport Safety Bureau (ATSB)

Released in accordance with section 25 of the *Transport Safety Investigation Act 2003*

Publishing information

Published by: Australian Transport Safety Bureau
Postal address: PO Box 967, Civic Square ACT 2608
Office: 62 Northbourne Avenue Canberra, Australian Capital Territory 2601
Telephone: 1800 020 616, from overseas +61 2 6257 4150 (24 hours)
Accident and incident notification: 1800 011 034 (24 hours)
Facsimile: 02 6247 3117, from overseas +61 2 6247 3117
Email: atsbinfo@atsb.gov.au
Internet: www.atsb.gov.au

© Commonwealth of Australia 2016



Ownership of intellectual property rights in this publication

Unless otherwise noted, copyright (and any other intellectual property rights, if any) in this publication is owned by the Commonwealth of Australia.

Creative Commons licence

With the exception of the Coat of Arms, ATSB logo, and photos and graphics in which a third party holds copyright, this publication is licensed under a Creative Commons Attribution 3.0 Australia licence.

Creative Commons Attribution 3.0 Australia Licence is a standard form license agreement that allows you to copy, distribute, transmit and adapt this publication provided that you attribute the work.

The ATSB's preference is that you attribute this publication (and any material sourced from it) using the following wording: *Source:* Australian Transport Safety Bureau

Copyright in material obtained from other agencies, private individuals or organisations, belongs to those agencies, individuals or organisations. Where you want to use their material you will need to contact them directly.

Addendum

Page	Change	Date

Safety summary

What happened

At about 1447 on 13 July, a fire started in the engine room of the bulk carrier *Marigold*, while it was loading a cargo of iron ore in Port Hedland, Western Australia (WA).

Firefighting by the ship's crew included activating the Halon gas fixed fire suppression system for the engine room. However, a full release of Halon gas did not occur, nor was the engine room effectively sealed. Consequently, the fire continued for about 12 hours until it burnt itself out.

What the ATSB found

The ATSB determined that the fire began on *Marigold's* number one generator after a fuel oil pipe fitting on it failed. The resulting spray of fuel oil likely contacted a hot surface on the generator and ignited.

The deployment of the ship's Halon gas fixed fire suppression system was ineffective, as a full release of Halon gas did not occur and the engine room was not effectively sealed. Failures within the Halon system and multiple failures of the ventilation closing mechanisms were indicative of a lack of effective planned maintenance on board.

The port's emergency response plan was initiated, but there were misunderstandings between the agencies involved as to the roles of the others during the initial stages of the incident and response. Their emergency plans did not refer to trigger points for transfer of control or include detailed instructions of how to hand over control during an incident.

What's been done as a result

The ATSB has been advised that as a result of this fire and another recent shipboard fire in Fremantle, WA, the State Emergency Management Plan for a Marine Transport Emergency (WESTPLAN MTE) has been revised. The WESTPLAN MTE now covers formal incident controller delegations.

Further, the WA Department of Fire and Emergency Services (DFES), the State's hazard management agency, has initiated new 'level 1' and 'level 2' marine firefighting training programs.

The operator of the ship's berth, BHP Billiton, will now provide international shore connections at its berths to improve water supply to a ship's fire line in emergencies. Additionally, BHP Billiton has aligned its standardised response checklists with those of DFES. The emergency response plan for shipboard fires will be consistent with these checklists.

Marigold's managers have taken action to address safety issues with regard to the maintenance and operation of the fixed fire suppression systems and ventilation closing mechanisms.

The ATSB has issued one recommendation to the ship's managers to further address the safety issue with regard to the operational status of fixed fire suppression systems. It has also issued five recommendations to DFES to address issues related to the shore response to shipboard fires.

Safety message

Response to a large fire on board a ship in port will involve the ship's crew and shore fire crews. The initial response and fire containment by the ship's crew requires a thorough knowledge and understanding of firefighting procedures and systems, knowledge which needs to be effectively maintained. Where multiple shore response agencies are involved, their emergency procedures need to be consistent with each other, such that individual and team roles and responsibilities are well understood and ensure that agencies can coordinate an effective response.

Contents

The occurrence	1
Fire detection and initial response	2
Call for shore-side assistance	3
Control attempts	4
Transition to recovery	6
Context	7
<i>Marigold</i>	7
Diesel generators	7
Halon system	7
Firefighting equipment (FFE) maintenance	9
On board emergency response	9
Port Hedland	10
Shore response to a shipboard fire	10
Port marine safety plans	11
DFES	12
Safety analysis	15
The fire	15
Fuel oil pipe fitting failure	15
On board response	16
Fire isolation and oxygen starvation	17
Halon system	18
Shore response	21
Incident controller	21
First responders checklist	22
International shore connection	22
Firefighting tugs	23
Firefighting capabilities in Port Hedland	23
Findings	25
Contributing factors	25
Other factors that increased risk	25
Safety issues and actions	27
General details	34
Occurrence details	34
Ship details	34
Sources and submissions	35
Sources of information	35
References	35
Submissions	35
Australian Transport Safety Bureau	37
Purpose of safety investigations	37
Developing safety action	37

The occurrence

At 0145¹ on 13 July 2014, the 309 m long bulk carrier *Marigold* (Figure 1) berthed at Finucane Island B berth at Port Hedland, Western Australia. The ship berthed port side alongside to the wharf, with the only access from the starboard side being via the ship's accommodation ladder. The loading of iron ore cargo started at 0600 with completion of cargo operations expected the next day.

Figure 1: *Marigold* port side to Finucane Island berth B



Source: Port Hedland Pilots

The chief mate, assisted by the third mate, monitored cargo loading operations from the ship's ballast control room (BCR) throughout the morning. As cargo loading progressed, the chief mate de-ballasted the seawater ballast tanks. The ship's number one and number two diesel generators provided electrical power for the ballast pumps and various other shipboard services.

Shortly after 1200, the third mate handed over the cargo watch to the second mate. At about 1300, *Marigold's* engineers and engine room ratings met in the engine control room (ECR). The chief engineer assigned them work, which included routine checks in preparation for the ship's departure from port. To progress the work, they split into three separate work teams (Figure 2).

Figure 2: Plan showing crewmembers locations in the engine room when the fire started

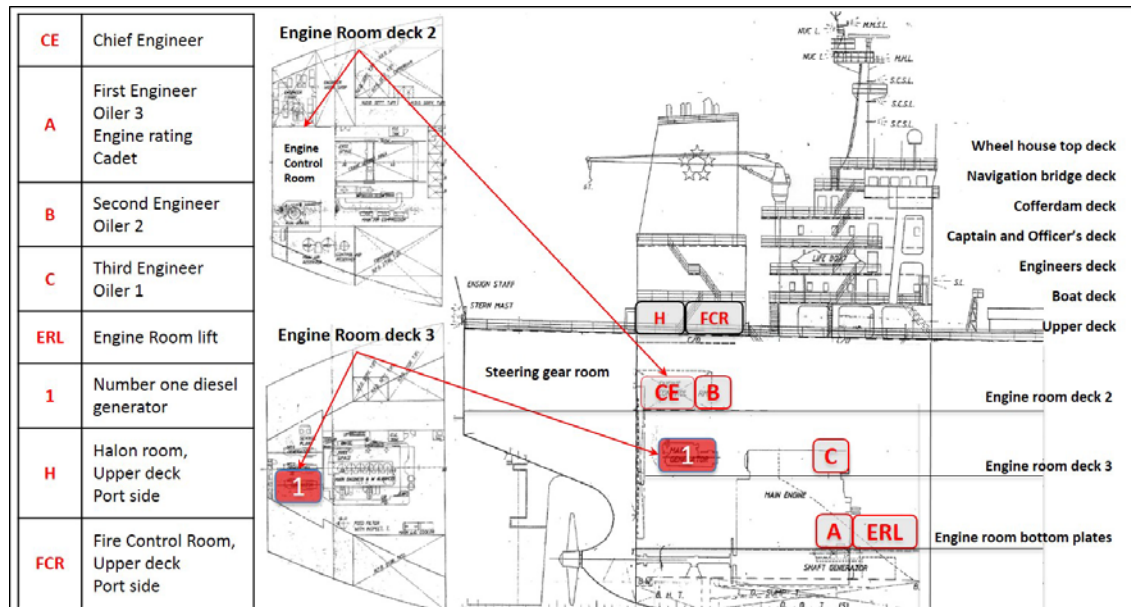

Source: *Marigold* (annotations by ATSB)

¹ All times referred to in this report are local time, Coordinated Universal Time (UTC) + 8 hours.

At 1420, the chief mate needed to use a third ballast pump. The chief engineer started a third generator, number three, to meet power requirements.

Fire detection and initial response

At about 1447, the ship's fire detection system activated on the bridge and in the BCR and ECR. Soon after, the ship's fire alarms began sounding throughout the ship and the accommodation fire doors closed automatically. The chief engineer, who was in the ECR with the second engineer and oiler 2, checked the fire detection panel, which indicated detectors had activated in the engine room. He went to investigate and saw smoke and flames coming from the generator flat (engine room deck 3).

Figure 3: Aerial view showing *Marigold* at Port Hedland



Source: Google earth (annotated by ATSB)

He attempted to extinguish the fire using a portable fire extinguisher but could not get sufficiently close because of the smoke. He returned to the ECR and phoned the duty seaman on the bridge, confirming there was a fire in the engine room.

Meanwhile, after the chief mate checked the fire detection panel, he stopped the ballast pumps and left the BCR to investigate the fire alarms. He tried to descend the internal stairs from the boat deck to the upper deck and enter the engine room. However, thick black smoke was building up quickly, so he left the accommodation and proceeded out onto the boat deck.

At the same time, the second mate went to the ship's bridge, where the master joined him. The duty seaman relayed the information he had received from the chief engineer, confirming a fire in the engine room.

At about 1448, the master sounded the general emergency signal, while the second mate instructed the wharf supervisors to stop cargo operations.

The second mate then announced over the ship's public address system that there was a fire in the engine room and directed all crewmembers to their muster stations.

Meanwhile, audible fire alarms alerted the first engineer, who was on the engine room bottom plates. He instructed his team to leave the engine room using the lift. He could now smell smoke and decided to locate the seat of the fire.

About the same time, on deck 3, the third engineer and oiler 1, also alerted by the audible fire alarms and the smoke, began making their way out of the engine room. The third engineer found

his way to the ECR but the oiler became disoriented in the smoke and took an alternative route to exit the engine room.

Call for shore-side assistance

At 1450, the master reported the fire to the Port Hedland shipping control tower (SCT) and asked for immediate assistance. He also contacted the ship's local agent and requested firefighting teams to assist.

In the SCT, the duty vessel traffic services officer (VTSO) began coordinating an emergency response. He requested the Western Australian Department of Fire and Emergency Services (DFES), BHP Billiton emergency services, Port Hedland pilots, harbour tugs and the local police to respond to the emergency.

By this time, the third mate had joined the master on the bridge. Meanwhile in the engine room, the first engineer had reached deck 3, but could see little in the dense smoke. He ascended a nearby ladder and managed to locate the ECR windows. He banged on the windows to attract attention, until the men inside pulled him in through the ECR door.

At about 1453, the chief, first, second and third engineers and oiler 2 left the ECR through the aft fire door into the steering gear room. By now, the disoriented oiler 1 had ascended several ladders searching for an exit from the engine room.

At about 1456, several crewmembers gathered fire hoses from the fire control room (FCR) and started preparing them on the upper deck for boundary cooling.² Shortly after, oiler 1 came out through an exit between the funnel housing and accommodation block on the upper deck, where he was met by crewmembers.

By now, the chief, first, second and third engineers and oiler 2 had ascended the exit ladder from the steering gear room, out on to the upper deck, aft of the funnel housing.

Meanwhile, three harbour pilots reported into the SCT. Upon sighting smoke issuing from *Marigold's* engine room and accommodation, two pilots left the SCT and proceeded to the pilot boat for transfer to the ship.

At about 1457, following a head count, *Marigold's* chief mate reported to the master that all crewmembers were present.

Shortly after, the master told the chief mate to close all fire and smoke dampers³ and shut down the generators. He relayed the instructions to the mustered crewmembers, and several of them started closing the dampers. The chief engineer then operated the fuel oil quick-closing valves⁴ (QCV) from the FCR on the upper deck.

At 1501, all three diesel generators shut down and electrical power was lost. Shortly afterwards, the emergency generator started and restored power to the emergency switchboard.

At about this time, DFES' Pilbara superintendent dispatched the acting area officer (AO) from Karratha to Port Hedland, (about 245 km away).

Meanwhile, the crewmembers continued to close the dampers, and about 30 minutes after the first fire alarm, the chief mate reported to the master that all engine room dampers and QCVs were closed. He then took another head count and confirmed all crewmembers were accounted for.

² Cooling of the structure around the fire origin to lower the temperature and reduce heat transfer to adjacent compartments.

³ A damper is a device installed in a ventilation duct, which under normal conditions remains open allowing flow in the duct, and is closed during a fire, preventing the flow in the duct to restrict the passage of fire.

⁴ Remotely operated pneumatic quick closing valves used to shut off the fuel supply to machinery in case of emergency.

Control attempts

At 1517, the master told the chief mate to activate the engine room Halon gas fixed fire suppression system (Halon system). The chief mate and chief engineer entered the FCR and activated the system.

At about 1520, six BHP Billiton emergency services officers (ESOs) and two South Hedland Volunteer Fire and Emergency Services (VFSR) firefighters arrived at the Finucane Island north gate (Figure 3) in support vehicles and fire appliances. Once on the wharf, they started preparing fire hoses and firefighting equipment.

Meanwhile, the two harbour pilots boarded *Marigold* from a pilot boat. The master briefed the pilots on the bridge about the situation, where one of them remained to assist with ship-shore communications.

The other pilot went down to the upper deck to provide on-scene updates and assist the crewmembers. Upon his arrival, the chief engineer briefed the pilot about the situation and informed him that he had activated the Halon system. The chief engineer opened the Halon room door to show the pilot, but the room was full of gas and prevented entry, so he closed the door.

Nearby, the crewmembers had mustered forward of the accommodation and two of the crewmembers appeared to be suffering from smoke inhalation. Seeing them, the pilot requested his colleague on the bridge to ask the SCT to send medical assistance.

At 1525, one harbour tug (Figure 4) started boundary cooling and another tug started pushing the ship onto the wharf. Consequently, the master informed the chief engineer to stop the emergency generator and close its dampers to prevent water spray from entering its air intakes.

Figure 4: Harbour tug boundary cooling the engine room



Source: Port Hedland Pilots

At about this time, the BHP Billiton emergency services supervisor (ESS) arrived at Finucane Island north gate. The senior ESO and senior VFRS firefighter briefed him and he then assumed the role of the shore response on-scene incident controller (IC). There was no access to the ship from the wharf because the shore gangway at that berth was not operational at that time. Hence, the pilot on the upper deck briefed the IC regarding the on board situation via VHF radio.

At 1535, the South Hedland VFRS senior firefighter advised the AO that there was a fire in the ship's engine room and the crew had released Halon into it. Although the crew had closed all

engine room dampers there was still a lot of smoke coming from them. Subsequently, the senior firefighter informed the IC that the AO from Karratha was expected at the scene at 1730.

The IC sent an ESO to board the ship via a workboat to attend to the smoke-affected first engineer and oiler. Meanwhile, the ship's crewmembers assisted other ESOs (who were on the wharf setting up fire hoses) with the transfer of a fire hose up and on to the ship's upper deck. Shortly after, the duty Port Hedland volunteer fire services (VFS) firefighter arrived on the wharf with additional equipment.

At about 1550, the ESO completed preparations for the medical evacuation of both smoke-affected crewmembers. The Port Hedland pilot transfer helicopter evacuated the injured crewmembers from the ship and transferred them to the local hospital for treatment.

At 1610, four ESOs boarded *Marigold* via a launch, using the ship's aft accommodation ladder. A third harbour pilot, from a nearby ship also boarded to assist with communications. Once on board, the ESOs and two pilots set up a staging area near the accommodation block on the upper deck and planned an engine room entry.

Meanwhile the AO had contacted the DFES regional command and discussed the situation. They decided that as the ship's crewmembers had discharged the Halon gas into the engine room, it was to remain closed for 72 hours, boundary cooling was to be maintained, and temperatures monitored. Additionally, DFES specialised 'vessel entry' firefighters were mobilised to leave Perth (about 1,650 km from Port Hedland) on a flight the next day. The AO phoned the IC and gave him this information.

At 1648, the IC tasked two ESOs to take bulkhead temperature readings around the engine room, but not to enter it. Wearing breathing apparatus (BA) and carrying a charged fire hose, they descended into the steering gear room and started taking temperature readings. As they moved around the steering gear room, they passed through two open fire doors and entered the ECR, where they recorded temperatures of up to 100 °C. They did not investigate the engine room any further.

Shortly after, the IC withdrew the ESOs from the ECR and the ship's master decided to disembark non-essential crewmembers using a launch to transport them ashore.

At about 1730, the AO arrived at the berth and the IC updated him on the situation. Shortly after, the ESOs reported smoke and a possible secondary fire in the engine room. The tugs maintained boundary cooling.

At about 1758, the pilots advised *Marigold's* master that the ship's mooring lines would need to be tended with the rising tide. Without electrical power, crewmembers would need to manually handle the lines, so the master arranged for them to return to the ship.

At 1820, the ESOs reported that temperatures had stabilised, however, smoke emissions from the engine room soon increased again.

At 2004, the AO took over as IC from the ESS. Subsequently, the ESS assigned the IC an ESO (also a South Hedland VFRS fire fighter) as the on-scene BHP Billiton liaison officer. Shortly after, both the AO and ESO boarded *Marigold* and began an assessment.

At 2116, the ESOs reported increasing temperatures again and heavy smoke from the engine room. The IC called the SCT and asked that 20 m³ of CO₂ be delivered to the ship for use in the engine room to suppress the fire. Consequently, the Port Hedland harbour master liaised with the BHP Billiton emergency services shore management to organise the CO₂.

At 2233, *Marigold's* master and chief engineer, accompanied by the IC and two pilots, inspected the Halon room. They found that one of the two banks of Halon bottles had partially released while the other bank had not discharged at all. They also found that only one of the two Halon gas distribution valves to the engine room had opened. The chief engineer tried manually releasing the remaining Halon bottles into the engine room, but he was unsuccessful.

Shortly after midnight, the IC and a pilot entered the steering gear room wearing BA. They found both fire doors leading into the ECR open and closed them to better seal the engine room. Boundary cooling continued throughout the night and temperatures remained steady.

Transition to recovery

At 1330 on the following day, 14 July, the specialised DFES ‘vessel entry’ firefighters boarded *Marigold*. They confirmed that the fire had burnt out and, hence, the previously arranged CO₂ was not required. The AO then handed the IC responsibility to a senior ‘vessel entry’ fire fighter.

At 1912, the ‘vessel entry’ firefighters inspected the engine room and found significant damage to number 1 generator and all electrical systems and wiring. Additionally, most of the switchboards in the generator flat and ECR were damaged beyond repair, making the other two generators inoperable.

Marigold's accommodation block had considerable smoke damage throughout, rendering the crew accommodation uninhabitable.

Later that evening, DFES firefighters re-assessed the situation and informed the ship's master that they considered it safe to start the emergency generator.

Figure 5: *Marigold* departing Port Hedland under tow



Source: Port Hedland Pilots

At 2000 on 15 July, DFES officers completed atmosphere testing in the accommodation and engine room. They determined that persons entering those spaces needed to wear respiratory equipment.

At 1045 on 16 July, DFES's IC handed over charge to the Port Hedland harbour master. It was then decided to move the ship to an anchorage.

On 17 July, the harbour master arranged for two shore generators to be placed on the ship to power its steering gear, mooring winches, and temporary lighting.

At 1330 on 19 July, *Marigold* was shifted to an anchorage with eight tugs in attendance while awaiting towage to a suitable port for repairs.

On 23 July, *Marigold* was towed from the anchorage, bound for Singapore for repairs (Figure 5).

Context

Marigold

At the time of the fire, *Marigold* was registered in Panama, classed with the Korean Register of Shipping (KR) and managed by Korea Leading Company of Ship Management (KLCSM), South Korea. Including the master, the ship had a crew of 23 Korean and Burmese nationals.

The master had 30 years of seagoing experience, including 12 years as master on large bulk carriers. He had joined *Marigold* about 2 months before the incident.

The chief engineer had 40 years of seagoing experience, including 26 years as chief engineer on large bulk carriers. He had sailed as chief engineer on board *Marigold* about 8 years previously and re-joined the ship about 2 months before the incident.

The chief mate had 25 years of seagoing experience, including 10 years as chief mate and held a chief mate's certificate of competency. He had sailed on a sister ship to *Marigold* for 8 months and joined *Marigold* 2 months before the incident.

Diesel generators

Marigold was equipped with three SsangYong MAN B&W medium speed, turbocharged, six cylinder diesel engine-driven generators. The generators were located at the aft end of the engine room, on deck 3, directly below the ECR. They each provided 650 kW of electrical power.

Figure 6: Diesel generator fuel oil supply system

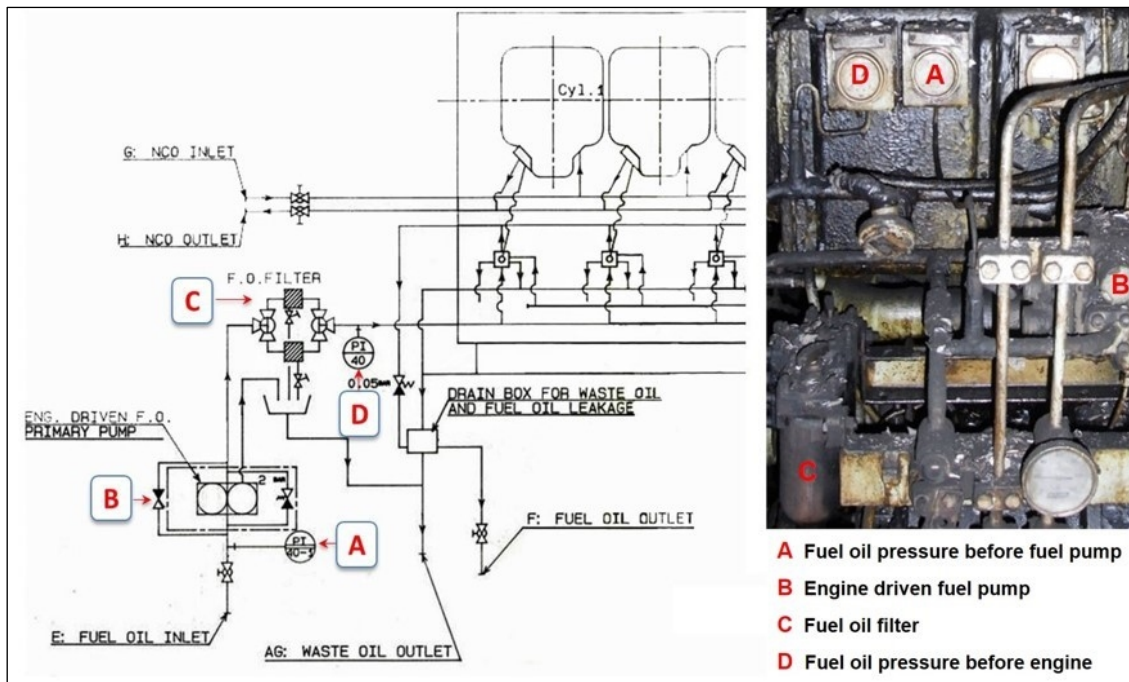

Source: SsangYong instruction manual, annotated by the ATSB

At the engine, a low-pressure gear pump circulated fuel through a fuel filter to the main fuel oil injection pumps. Two pressure gauges (marked 'A' and 'D' in Figure 6) indicated the fuel oil pressure before the fuel pump and fuel oil pressure before the engine.

Halon system

A Halon 1301 fixed fire suppression system (Figure 7) protected *Marigold's* engine room. Halon 1301 (Halon), the common name for bromotrifluoromethane, is a colourless, odourless gas with low toxicity and a density about five times that of air. Halon does not extinguish fires through oxygen starvation, but inhibits the chemical process in which a substance reacts rapidly with

oxygen and gives off heat. It has excellent fire extinguishing properties and is a clean agent because it leaves no residue, but it has a high ozone depleting potential.

The Halon was stored under pressure (42 bar⁵), as a liquid, in two banks of 130 L⁶ bottles in the Halon room, located on the port side of the upper deck (Figure 2).

Release of Halon from the bottles and operation of the distribution valves utilised a carbon dioxide (CO₂) pilot system. The pilot CO₂ bottles were located in identical control boxes in the Halon room and the fire control room (FCR).

When an operator opened the door of a control box, a switch activated audible and visual alarms in the engine room and stopped the ventilation supply and exhaust fans. Next, the operator opens the pilot CO₂ bottle valve and CO₂ flows to pneumatic actuators, which open the main distribution valves prior to the release of Halon. As the main valve spindle rotates, a pilot valve fitted to the spindle also opens, allowing the CO₂ to flow to, and activate the Halon bottle release valves. The bottles simultaneously discharge the Halon, as a gas, into a common manifold system, discharging into the engine room via the distribution valves and pipework.

Figure 7: Marigold's Halon fire suppression system

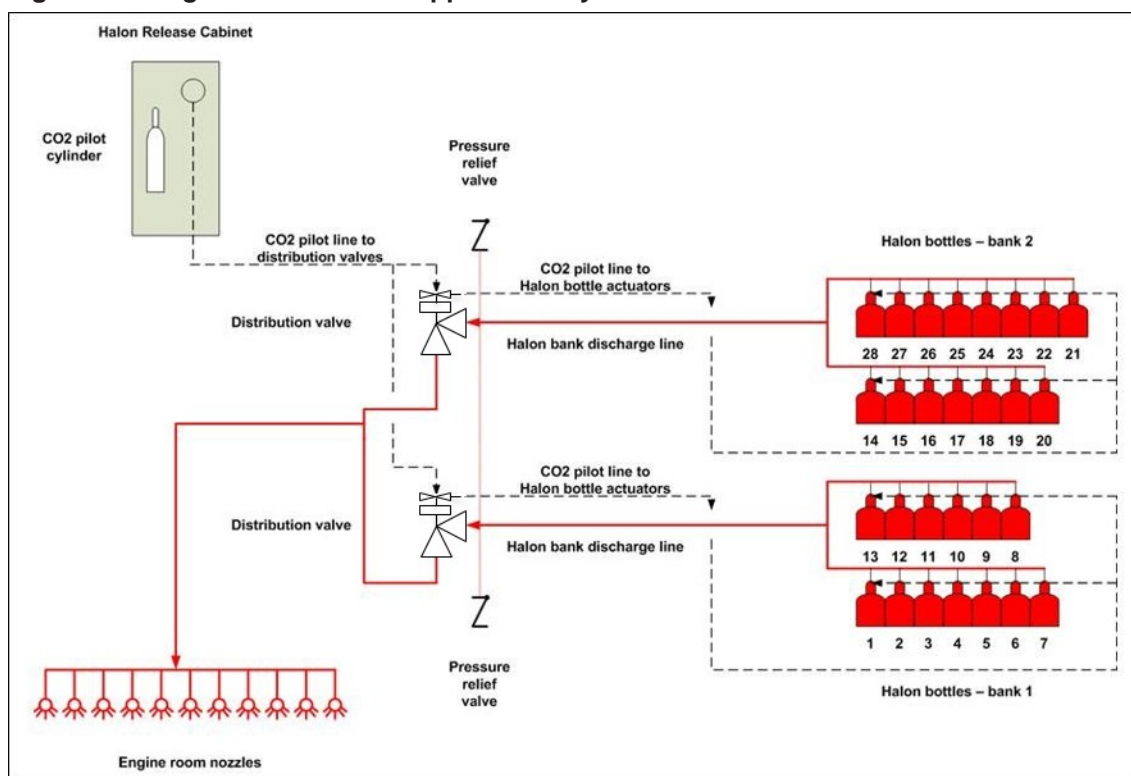

Source: ATSB

The Halon system operating instructions displayed in the Halon room and FCR stated:

Once the fire was extinguished, no one is to enter the engine room, until it was certain that there is no danger of re-ignition.

In 1987, the Montreal Protocol prohibited the use of ozone depleting gasses. These measures were adopted in SOLAS,⁷ which then prohibited:

- full-scale tests of Halon fire-extinguishing systems (from January 1992)
- installation of Halon fire-extinguishing systems on board ships (from 1 October 1994).

⁵ One bar equals 100 kPa or approximately one atmosphere.

⁶ 130 litres equates to 139 kg of Halon liquid.

⁷ The International Convention for the Safety of Life at Sea, 1974, as amended.

However, SOLAS did not specify any phasing-out requirement for Halon fixed fire extinguishing systems on existing ships. Some flag administrations provided instructions for decommissioning and replacement requirements for existing halon system. However, *Marigold's* flag State at the time of the fire (Panama) had no such requirements.

Firefighting equipment (FFE) maintenance

A merchant marine circular⁸ issued by Panama details the minimum recommended levels of maintenance and inspection requirements for FFE. This circular and the manufacturer's guidance formed the basis of *Marigold's* FFE maintenance procedures.

Testing and inspection

Testing and inspection of FFE was conducted at scheduled weekly, monthly, quarterly, annual, biennial, five-year and ten-year intervals. Trained personnel (either ship's crewmembers or service technicians) carried out the equipment testing and maintenance. *Marigold's* planned maintenance system (PMS) assigned the chief mate responsibility for the inspection and maintenance, and the chief engineer responsibility for controlling the equipment.

The PMS included testing of the following:

- fixed gas fire-extinguishing system
- fire doors
- ventilation systems (several types of mushroom ventilators were fitted and were closed by either rotating the ventilator head down with a hand wheel or by turning a fire damper handle connected to the damper flap inside the ventilator trunking)
- fire dampers (closure of the main engine room dampers required a wire connected via pulleys to the dampers blades to be pulled)
- remote closure of engine room hatch (a hand chain block suspended from the funnel housing bulkhead was used to lift and open the engine room hatch).

On board emergency response

Chapter III, Regulation 8 of SOLAS, *Muster list and emergency instructions*, requires ships to have:

- clear instructions for every person on board to be followed in the event of an emergency
- muster lists exhibited in conspicuous places throughout the ship, including the navigating bridge, engine room and crewmembers' accommodation spaces.

Marigold's muster list specified details of the general emergency signal and public address system, and additionally, crewmembers' duties when the emergency alarm sounded. Each crewmember was allocated an emergency duty based on rank and was assigned to the command teams or an on-scene team. The command teams mustered on the bridge and in the engine control room, with the master in overall command.

The on-scene team was comprised of two fire teams and an assistance party. The chief mate was the leader of fire team one and was in charge of the fixed fire-fighting system. Fire team 'one' was the primary firefighting team outside of the engine room. The first engineer was the leader of fire team 'two' and was in charge of isolating the electric power supply, mechanical ventilation and the emergency fire pump. Fire team 'two' was the primary firefighting team in the engine room. The second mate was the leader of the assistance party and in charge of first aid and medical treatment.

⁸ MMC 281 - Guidelines for the Maintenance and Inspection of Fire-Protection Systems and Appliances.

Additionally, *Marigold's* safety management system (SMS) contained emergency response procedures (ERP). The ERP detailed the on board emergency response to be followed by crewmembers for engine room fires, including the use of fixed gas suppression systems.

Training and familiarisation

Marigold's SMS also required each crewmember to complete an on board familiarisation. Upon joining the ship, each crewmember had to be familiar with their emergency duties before the voyage began. Additionally, within 2 weeks, they had to complete on board training in the use of all firefighting equipment (FFE). The training covered fire party duties, location of the muster station and an overview of the engine room fixed firefighting system.

Further, the company specified that the ship's crewmembers conduct monthly fire drills, in accordance with SOLAS requirements. The ERP listed 15 fire scenarios and required crewmembers to use a different scenario for each drill. Among others, the scenarios included simulated fires in the accommodation and engine room.

Fire boundary and isolation

Thermal and structural boundaries divided *Marigold's* spaces into vertical and horizontal zones. SOLAS classified these spaces according to their fire risk. Consequently, fire integrity standards applied to the boundaries, which formed the divisions between the adjacent spaces. The space classification determines the materials used to construct the solid divisions and openings therein.

The objectives of the fire boundaries defined by SOLAS were to:

- prevent the occurrence of fire and explosion
- reduce the risk to life caused by fire
- reduce the risk of damage caused by fire to the ship, its cargo and the environment
- contain, control and suppress fire and explosion in the compartment of origin
- provide adequate and readily accessible means of escape for passengers and crewmembers.

Port Hedland

Port Hedland (Figure 8) is Australia's largest bulk cargo port. It is located on the north-west coast of Western Australia and services the mineral rich Pilbara region. The port has 16 berths, including 12 privately owned iron ore berths, and a single shipping channel.

The port's major export commodity is iron ore. In the financial year ending 30 June 2014, more than 372 million tonnes of iron ore was exported on over 2,500 ships.

Pilbara Ports Authority (PPA) is responsible for the safety and efficiency of shipping in the port and its waters, for which it has overall responsibility for planning and development.

Figure 8: Port Hedland



Source: ATSB

Shore response to a shipboard fire

In Western Australia, the management of a marine transport emergency within port boundaries involves multiple agencies with overlapping responsibilities. The agencies include the Department of Transport, Western Australia (DoT), the port authority, the marine export facility owner, DFES

and the ship's master. The DFES recommends that a unified command structure⁹ be used by agencies responding to an incident.

The WESTPLAN MTE¹⁰ states that the port authority and the marine export facility owner perform the immediate response activities for a marine transport emergency (MTE)¹¹ within port boundaries. These organisations provide the IC¹² and act as the controlling agency.¹³

Additionally, DoT is the hazard management agency (HMA)¹⁴ for any MTE that occurs in all waters within the State. However, DFES assumes responsibility for incidents involving fire and any rescue that results from it.

The DFES only provides the IC if the incident requires a multi-agency response, or if requested by a port authority or the marine export facility owner. In instances of an incident requiring a multi-agency response, the IC is a suitably trained and qualified DFES officer. A comprehensive handover is required between the immediate response IC and the relieving DFES IC.

Port marine safety plans

All port authorities and private companies operating ports¹⁵ in Western Australia under the *Port Authorities Act 1999* are required to prepare, maintain and implement a 'marine safety plan'. These plans identify arrangements for managing MTE situations within port waters.

Hazard management structure/arrangements

When an MTE involving a ship fire is declared, the DFES has overall responsibility for control and coordination through the appointed IC. The IC will be a suitably trained and qualified officer from DFES, the port authority, or the maritime export facility owner.

PPA

The PPA maintains an emergency response plan (ERP). The objective of the ERP is to provide the DoT or DFES (as the HMA), with assistance, coordination and marine expertise to manage the incident. The plan provides guidance for the initial response and recommended remedial action to an emergency within the port limits.

There are three levels of response to incidents within PPA's jurisdiction:

- 'level 1' - can be resolved through the use of local or initial response resources only
- 'level 2' - requires deployment of resources beyond the initial response
- 'level 3' - requires multi-agency responses for effective management of the situation.

When a ship berthed in Port Hedland requires emergency assistance, the ship's master is required to contact the SCT.

⁹ Unified Command is a supporting principle to the Australasian Inter-service Incident Management System (AIIMS), which requires the inclusion of key decision makers from all combat agencies. The location of the vessel will determine which jurisdiction has responsibility for it, and what emergency response is appropriate.

¹⁰ The State Emergency Management Plan for a Marine Transport Emergency 2011 (WESTPLAN MTE) details responsibilities, response, and recovery from MTEs in Western Australian Waters.

¹¹ Marine Transport Emergencies, whatever their cause, may threaten or endanger life, property and/or the marine environment and require the coordination of a number of significant emergency management activities.

¹² The incident controller is the person who has the overall control of the incident scene. The IC has responsibility for determining the desired outcomes for the incident response and the management of response activities to achieve those outcomes.

¹³ An agency nominated to control the response activities to a specified type of emergency.

¹⁴ An agency designated to lead the response to emergencies in relation to the type of hazard for which it is prescribed.

¹⁵ Five port authorities under the Port Authorities Act 1999 - Fremantle Ports Authority (Port of Fremantle), Southern Ports Authority (Albany, Bunbury and Esperance), Mid West Ports Authority (Geraldton), Pilbara Ports Authority (Ashburton, Dampier and Port Hedland), Kimberley Ports Authority (Broome).

The duty vessel services traffic officer (VTSO) in the SCT then notifies a number of pre-identified parties, including:

- Port Hedland harbour master
- Port Hedland safety & security officer
- duty pilot
- DFES (on '000').

Additionally, PPA's ERP provides the following guidance for a fire on board a berthed ship:

The VTSO will also advise the local tug operators, pilot helicopter crew, and medical services an emergency exists and that they are required to standby for further instructions.

The Harbour Master will attend the SCT to co-ordinate the emergency response and the Duty Pilot will assist. Additionally, another senior marine pilot will proceed to the ship to assist the response coordination and provide updates to the SCT.

The Harbour Master will deploy suitably equipped tugs to assist with firefighting. The local VFRS officer will be on board a tug directing firefighting operations.

Throughout, the ship's master maintains responsibility for fighting fires on ships alongside berths, until the arrival of a Senior Fire Officer. The Senior Fire Officer will then assume overall direction of all available firefighting equipment, including the direction of the tug firefighting resources.

Marine export facility owner

The maritime export facility owner, BHP Billiton, also maintains an ERP. Under an agreement with the HMA, the BHP Billiton security and emergency management (SEM) teams will assist with shipboard emergencies at BHP berths.

The SEM supervisor (ESS) is the designated on-scene IC and is in command of the overall operations at the incident scene, including:

- developing and coordinating a strategic plan to combat the crisis or emergency
- ensuring that there are adequate resources available
- ensuring that operations are carried out safely and in line with procedures and protocols
- liaising with other emergency agencies.

Under the IC's direction, ESOs are responsible for the following:

- leading the first response team (FRT) actioning the strategic plan
- assessing medical response needs, and administering first aid/medical treatment
- ensuring emergency resources are ready and available.

DFES

The DFES response to an MTE is determined by the location of the incident and capabilities of the first arriving response unit. In regional ports (Figure 9) such as Port Hedland, the port authority is the first response agency (FRA) and DFES' volunteers provide fire services for marine fires. There is a heavy reliance on FRA's across most of WA.

The VFRS firefighters are stationed in South Hedland and a VFS firefighter is stationed in Port Hedland (both with designated marine fire roles). All VFS and VFRS firefighters are trained in marine fire assessment and containment (MFAC)¹⁶ techniques.

¹⁶ Volunteer team that initial responds to a marine fire incident alongside and has the appropriate training and equipment to assess the incident complexities and contain the fire by securing any holds, cabins or parts of the ship until additional expertise is mobilised

The ship firefighting cache¹⁷ in Port Hedland is used to support land-based marine fire responses. The DFES operations command unit in Karratha provides for the Pilbara region. Specialised ‘vessel entry’ firefighters or marine fire assessment and suppression capability (MFASC)¹⁸ brigades can also be deployed to regional ports. However, MFASC brigades are based in metropolitan areas (such as Perth) and comprise professional career firefighters. The brigades are provided the training and equipment to fight shipboard fires in port or at sea.

Figure 9: Regional first response agencies

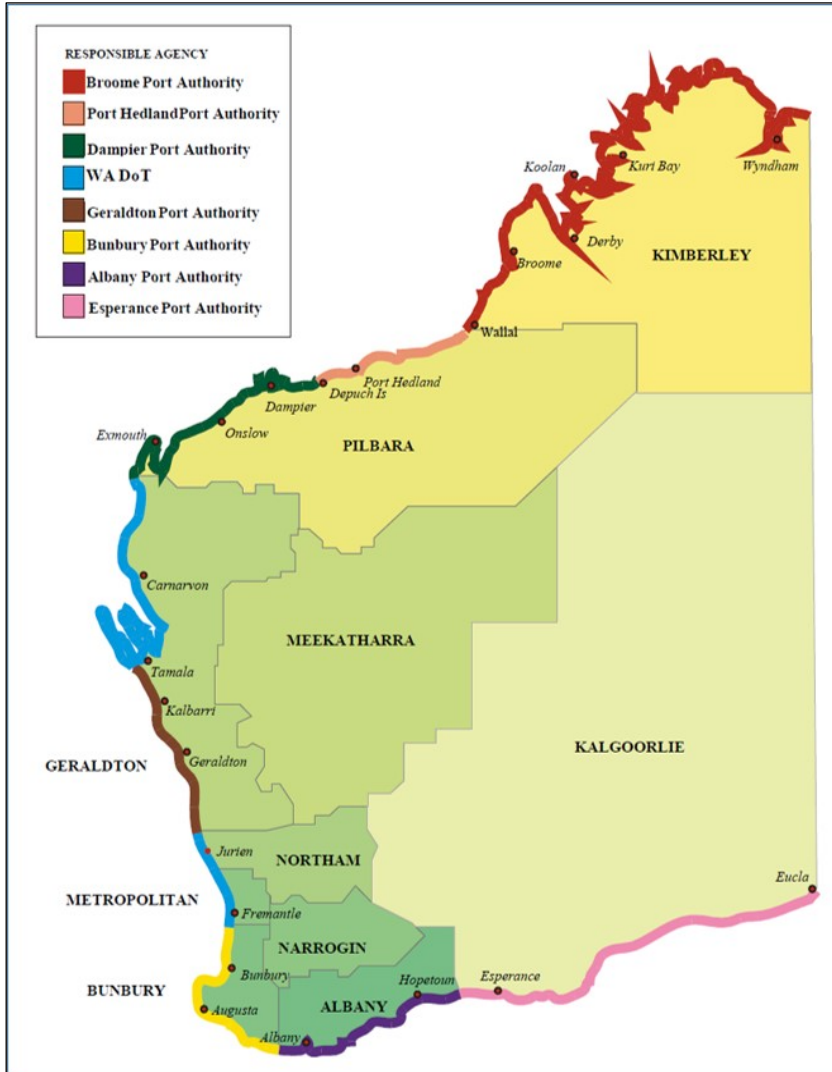

Source: WESTPLAN MTE

DFES’ Marine Fire Emergency Response Guide (MFERG)

The MFERG provides the first arriving DFES IC guidance to establish firefighting strategies and recording incident information. The guide contains the following information:

- decision model for vessel fire attack
- ship fire response check list

¹⁷ Equipment that mainly consists of couplings, spanners, connections and specialised thermometers to enable DFES firefighters responding to a shipboard fire. This cache is stored locally at the port.

¹⁸ Professional team that is an initial response to a marine fire incident either alongside or at sea and has the training and equipment to suppress that fire. This includes procedures, specialist equipment and adequate initial response and back up crews.

- temperature monitoring for ship fires
- temperature monitoring maps for ship fires
- draft mark recordings for vessel trim and list.

Before committing any resources to firefighting or other duties, the IC is required to conduct a dynamic risk assessment and decide an attack strategy, using offensive or defensive tactics.

DFES’ marine firefighting training

When DFES is asked to attend a shipboard fire, it is likely that the fire has progressed beyond the normal capabilities of the ship’s crew. Therefore, DFES firefighters are trained in specific areas of fighting marine fires applicable to their designated roles:

- marine fire assessment and suppression capability (MFASC)
- marine fire support (MFS)¹⁹
- marine fire assessment and containment (MFAC).

The DFES *Marine Firefighting Capability and Training manual* referenced engine room fires. In all events, restriction of oxygen flow to the fire was required, and for serious fires, the use of fixed firefighting installations was to be considered. The manual stated:

The use of fixed installations is unlikely to be effective if its introduction is delayed for an excessive period of time, due to high temperatures building up in the engine room compartment.

After flooding an area with CO₂, the area should be left closed for sufficient time to allow the burning materials to cool below their ignition temperature.

Additionally, prior to entry into the affected spaces, three successive significant temperature reductions across all boundaries were required. The last temperature reduction at the hottest boundary needed to be a reading below 50°C. Further, readings returning to ambient temperature were indicative of the fire being extinguished.

The manual also indicated that generally, if a fire involved cable insulation and lagging, a longer period would be required before the heat dissipated, as these materials may continue to smoulder for some time.

¹⁹ A firefighting team that is fully conversant with supporting a marine fire alongside, and is able to back up a MFASC Brigade, and has the training and understanding of equipment. These teams are not expected to enter interior areas on a burning vessel.

Safety analysis

The fire

On 13 July, while *Marigold* was loading cargo in Port Hedland, a fire started in the ship's engine room. The fire began on the ship's number one generator after a fuel oil pipe fitting on it failed. The resulting spray of fuel oil likely contacted a hot surface and ignited.

The firefighting response included deploying the ship's Halon fixed fire suppression system. However, a full release of Halon gas did not occur and the engine room was not effectively sealed. Consequently, the fire continued for about 12 hours until it burnt itself out.

Fuel oil pipe fitting failure

The generator's fuel system pressure gauge piping originally consisted of continuous steel pipe connecting the fuel line to the pressure gauge. However, at some time in the past, a different type of pressure gauge had been fitted to the piping (fuel oil pressure before the engine). While the replacement gauge had a similar back mounting arrangement to the original, its connection fittings were incompatible with the original pipework, and it could not be directly connected to the piping. Therefore, the gauge had been connected to the original steel pipe using a section of copper pipe and a compression fitting (Figures 10 and 11).²⁰

Figure 10: Comparison between generator pressure gauges and gauge pipework

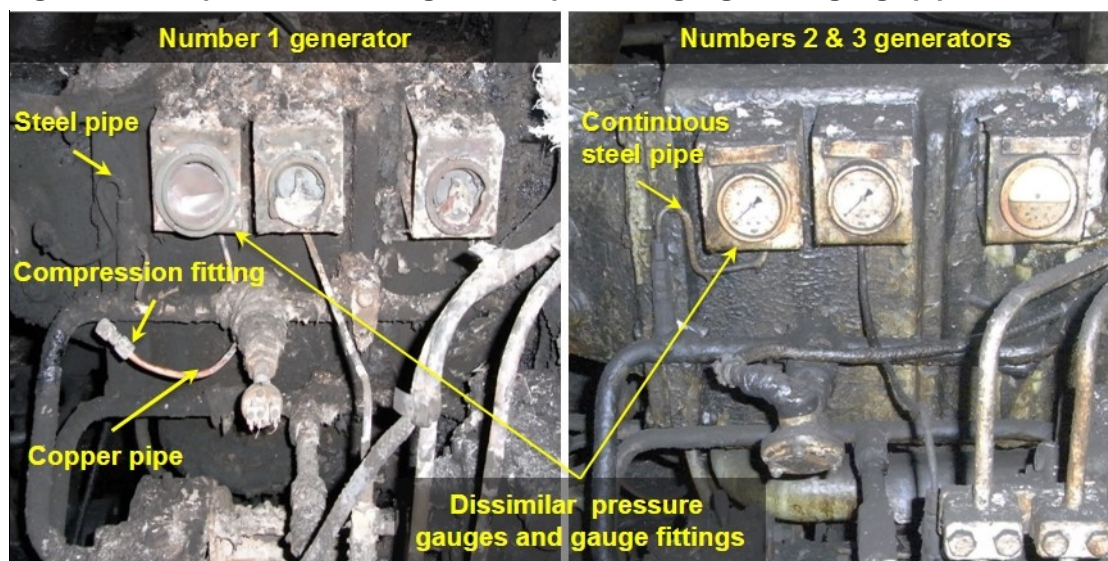

Source: ATSB

Although the steel and copper pipes had the same nominal internal diameter, they had different outer diameters. Consequently, when the compression fitting was tightened, it is likely that the steel pipe was not adequately secured, and it separated from the fitting in the time leading up to the fire. The resulting spray of pressurised fuel oil produced a thin oil film that spread over a large area (Figure 11). It is likely that the oil film contacted a hot surface on the generator and ignited, resulting in a fire around its turbocharger.

²⁰ Compression fittings are a basic style of tube fitting and are made up of three parts to complete a tubing joint: an olive (ferrule), nut and body. The joint is made by inserting the tube down to the tube stop and tightening a nut – creating a seal by conforming the olive to the shape of the radius and taper of the body and nut.

Figure 11: Fuel oil spray from compression fitting

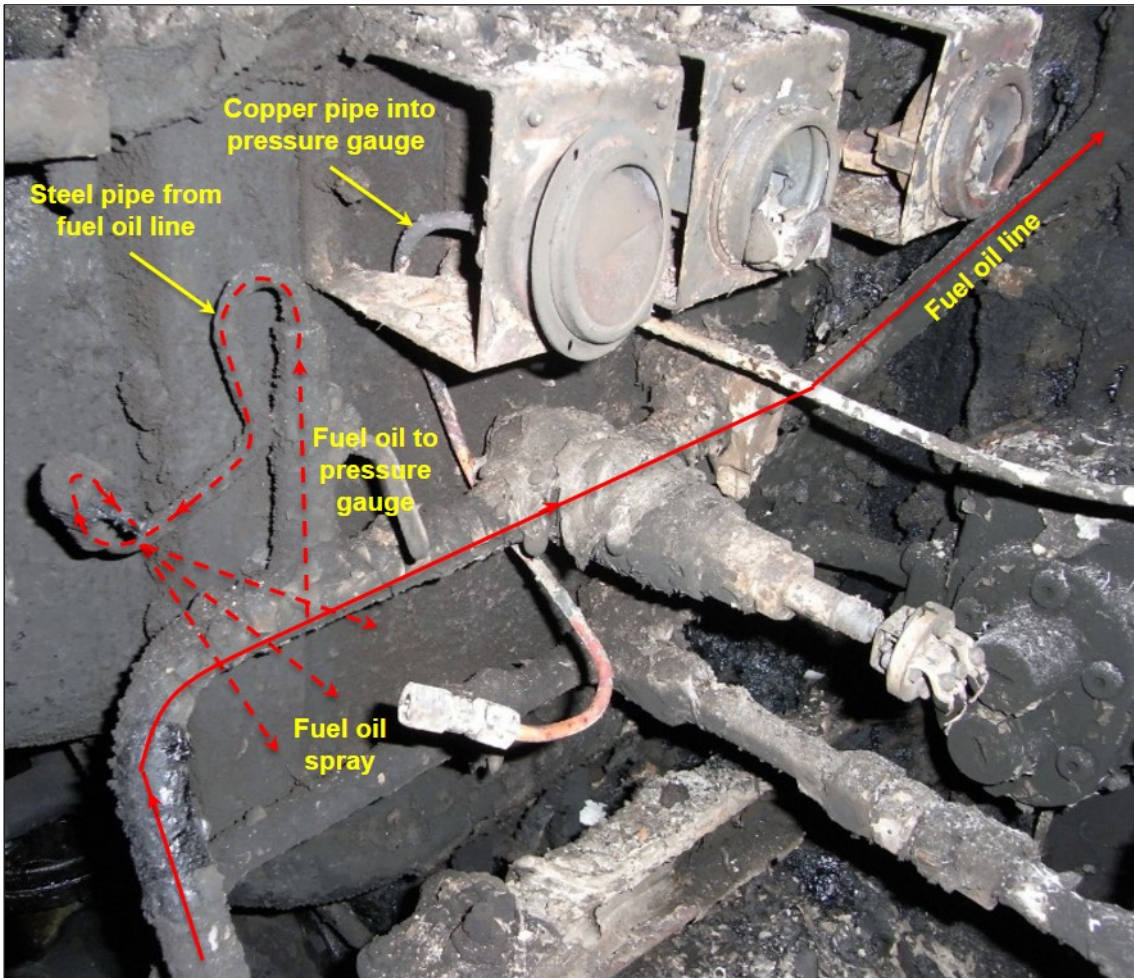

Source: ATSB

On board response

Evacuation via engine room lift

On 13 July, when alarms indicating the engine room fire sounded, the first engineer and three crewmembers were on the bottom plates - the lowest level of the engine room

Figure 12: Engine room lift and adjacent ladder

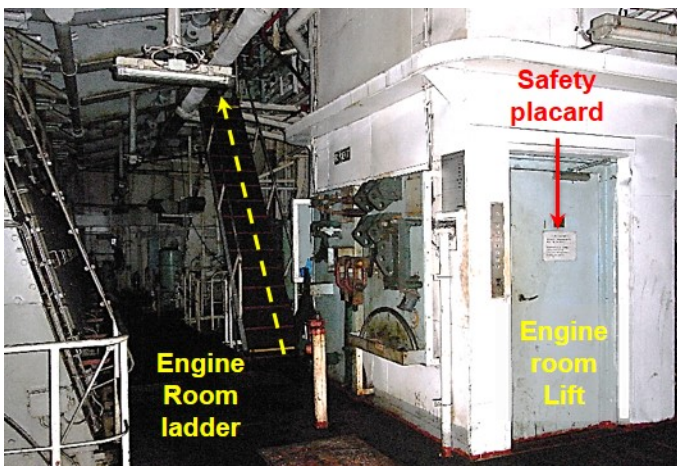

Source: ATSB

The first engineer ordered his team to evacuate using the engine room lift. The lift accommodated only three persons, so the first engineer ascended the engine room ladder to make his exit (Figure 12).

It is universally accepted practice not to use a lift in an emergency due to the unacceptably high risk of becoming trapped in the lift if the power fails. Safety placards on the lift doors also warned 'Caution, lifts are not be used in the event of an emergency'. The crew took an unnecessary risk by using the lift.

Fire isolation and oxygen starvation

Containing a shipboard fire in the space where it starts requires the integrity of thermal and structural boundaries to be maintained. Further, limiting the fire growth potential in the space relies on preventing or restricting the air supply to it.

Openings in the structural boundaries in accommodation and machinery spaces are fitted with fire doors (those in the accommodation are usually self-closing). The doors are designed to provide a restriction to the passage of smoke and flame equivalent to that of the division in which they are fitted. Fire doors fitted in boundary bulkheads of machinery spaces shall be gastight and self-closing. Regulations require that self-closing doors are not fitted with hold-back hooks.²¹ However, hold-back arrangements fitted with remote release devices of the fail-safe type may be utilised.

Structural boundary close down

All fire doors on board *Marigold* should normally have been in a closed position. However, ATSB investigators found the fire door leading to the engine room from the upper deck inside the accommodation had been tied open (Figure 13).

Figure 13: Fire door tied open

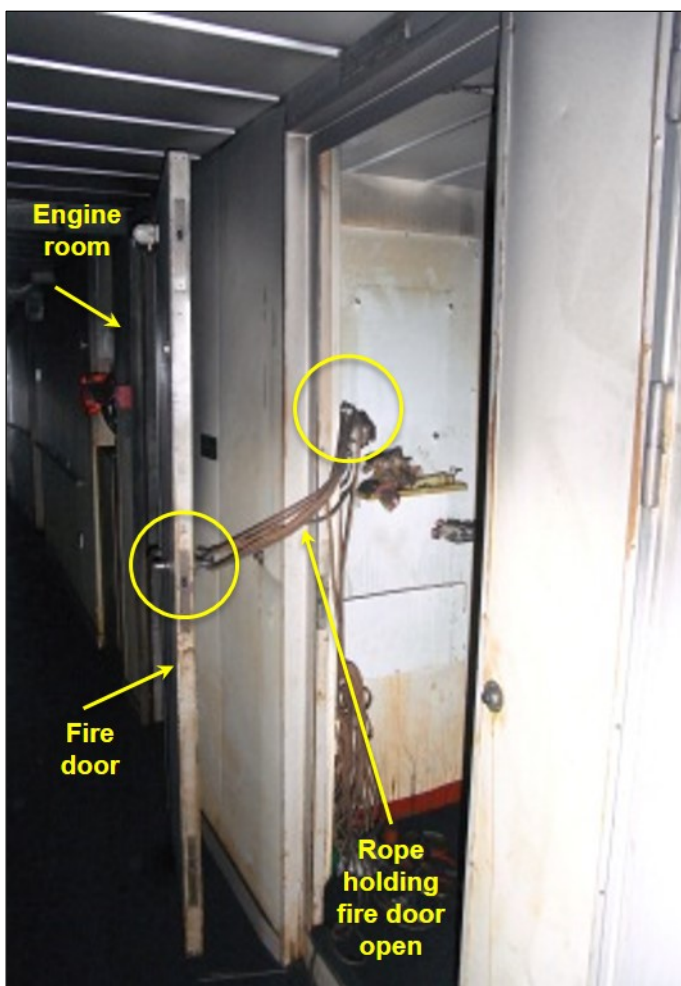

Source: ATSB

Similarly, the fire door leading to the ECR from the steering gear room had been wired open.

The fire door from the accommodation remained open throughout the fire and the extended firefighting efforts. Consequently, smoke entered the accommodation and substantially affected/damaged it.

Post-fire atmospheric testing indicated that the accommodation remained uninhabitable over the following 2 days. During that time, the ship's crew would have been exposed to a hazardous and toxic atmosphere containing combustion products.

Some crewmembers indicated their understanding that fire doors were to be kept closed or were designed to close automatically. However, the evidence indicates that routinely tying back some of those doors open was accepted practice on board. This increased risk in the event of a fire as it negated the purpose and function of these doors.

²¹ SOLAS 1981 Chapter II-2, Regulation 47, Doors in fire resisting divisions.

Closedown of the engine room ventilation

At about 1457, *Marigold's* master ordered all engine room ventilation isolations closed. Over the next 20 minutes, crew went about closing mushroom ventilators, fire dampers and the engine room hatch.

However, a number of mushroom ventilators and dampers could not be fully closed. The closing mechanisms of these openings were difficult or impossible to operate – indicative of inadequate maintenance of this critical equipment over an extended period. Consequently, the engine room was not effectively isolated; smoke continued to billow from the openings, and air entering the engine room sustained the fire (Figure 14).

Figure 14: Smoke billowing from engine room ventilators

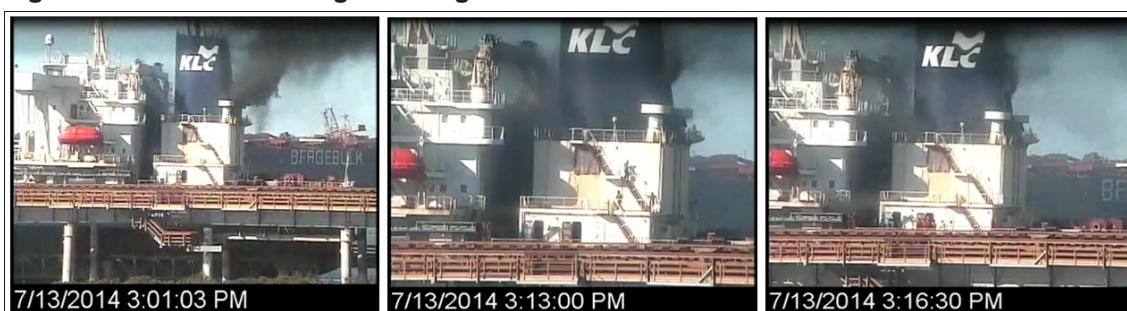

Source: PPA

The continuing flow of air to the fire was further exacerbated by an inability to close the engine room hatch. Heavy smoke prevented the crew from reaching the chain block used to hold the hatch open.

At 1517, although the engine room was not effectively isolated, the chief mate reported that it had been closed down. Hence, the master ordered Halon gas released into the engine room. While the Halon gas may have suppressed the fire had the engine room been sealed, its impact was limited due to the openings and fire doors that were not closed.

Loss of electrical power

In response to the fire, *Marigold's* main generators were stopped. The emergency generator then started, providing power for emergency services, including a fire pump, lighting and essential services.

A short time later, a harbour tug started boundary cooling the ship's engine room. The master was then advised that the ship's fire pump was not required for boundary cooling. Consequently, he asked the chief engineer to stop the emergency generator and close its air intakes. From this time onwards, the ship had no electrical power and was unable to effectively support the firefighting.

Halon system

Main distribution valve failure

On the master's orders, the chief mate and chief engineer entered the FCR and operated the Halon system to release gas. However, unbeknown to them at the time, a full release of the gas did not occur.

During their investigation on board the ship, ATSB investigators found only one of the two main distribution valves had opened. This meant that the pilot CO₂ system had only activated the Halon gas bottles of 'bank 2' (Figure 15). Therefore, there was only a partial release of Halon gas into the engine room.

The ATSB identified a number of possible reasons for 'bank 1' main distribution valve not opening, including the:

- pilot CO₂ gas bottle had insufficient pressure
- pilot CO₂ gas bottle was not left open for sufficient time
- pilot CO₂ gas bottle was not fully opened/could not be fully opened
- pilot CO₂ gas piping was leaking and sufficient gas leaked out to cause the partial failure.

Halon gas bottle valve failures

The pilot CO₂ gas flowing via the open distribution valve should have activated the release valves of all the Halon bottles. However, several bottle release valves failed to activate. Further, when the chief engineer manually activated every bottle on each bank, several release valves also failed to activate (Figure 15). Investigators later found that individual bottle pressure gauge readings across the two banks varied across a wide range (0 to 50 bar).

Figure 15: Halon bottle pressures after release

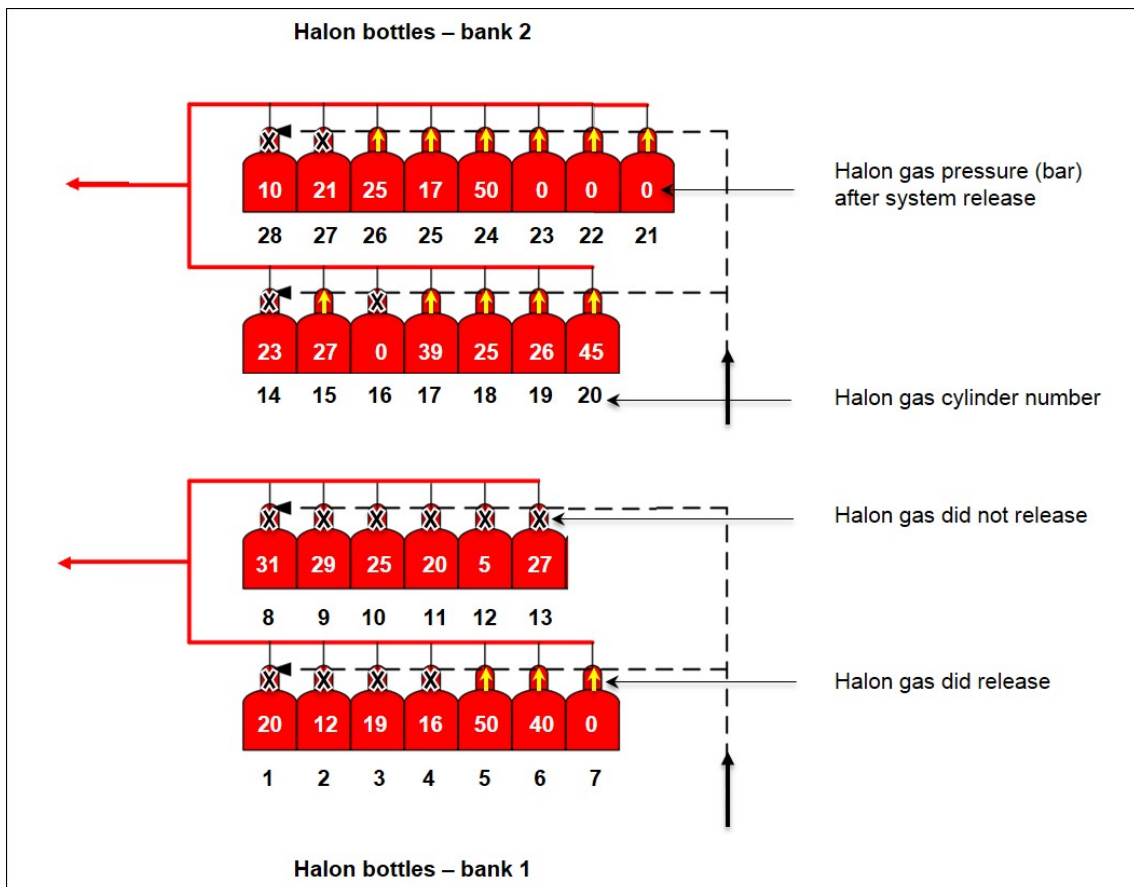

Source: ATSB

The ATSB investigation identified a number of possible reasons for the failure of the Halon gas bottles to discharge, which include:

- inaccurate bottle pressure gauges
- insufficient bottle charge (low pressure)
- failure of bottle release valves to operate
- holed (leaking) individual pilot CO₂ flexible hoses.

System operation and awareness

Marigold's SMS procedures required the crewmembers responsible for the Halon system to be familiar and competent in its operation.

At interview, both the chief engineer and chief mate stated that they understood the system, when activated, was designed to release only half of the Halon bottles. They indicated that the fixed fire suppression systems on ships they had previously sailed on had operated in this manner. However, *Marigold's* Halon system was designed to release 100 percent of the gas bottles when activated.

At about 2200, with smoke emissions increasing, the pilots inspected the Halon room and found approximately half the Halon bottles had been activated. However, one distribution remained in the closed position. They informed the IC and *Marigold's* master and a further inspection of the Halon system was undertaken. It was concluded that the system had not functioned as intended. The master then ordered that the remaining bottles be manually discharged.

In following the master's instruction, the chief engineer started removing the bottle head release pins and discharging each bottle into the main manifold. However, as the main distribution valve from bank '1' had failed to open and was still closed, the manual release of Halon gas over-pressurised the manifold and relief lines. These lines were in a heavily corroded, poor condition and the over-pressure condition caused the failure of the lines' pressure relief system, allowing Halon gas to disperse into the atmosphere (Figure 16).

Figure 16: Halon manifold relief pipe work

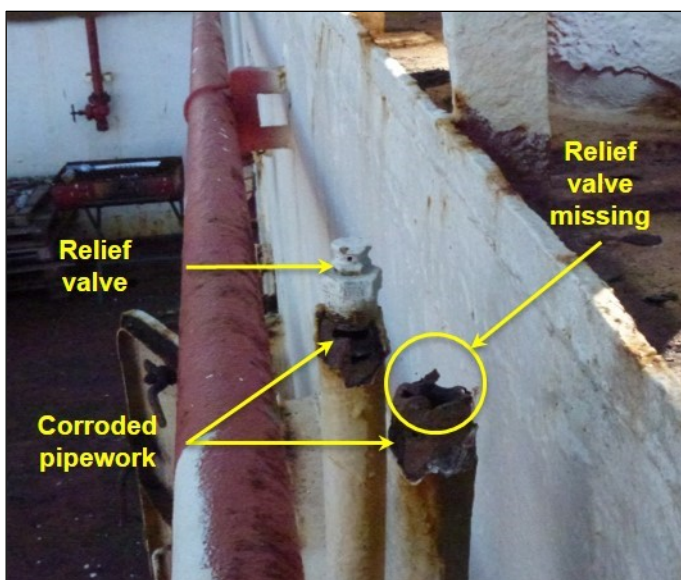

Source: ATSB

The investigation also identified that the main distribution valves were designed so that they could be manually opened whether or not the line was pressurised.

Therefore, a secondary method of operating the system was available. However, none of the ship's crew was aware of or understood this back up method. Had they been thoroughly familiar with the system and its operation, they would have become aware of its partial failure, been able to take action to mitigate against it, and modified their firefighting and control strategies.

Maintenance

The ship's planned maintenance system (PMS) listed the FFE requiring testing and inspection at regular intervals. Additionally, the PMS incorporated the flag State's guidelines²² for maintenance and inspection of the FFE.

The testing and inspection routines for the fixed fire-extinguishing system (Halon system) were scheduled at weekly, monthly, annually, biennial, 5-yearly and 10-yearly intervals. Therefore, the failed components identified by investigators should have been tested and inspected numerous times as per the PMS-scheduled routines. Had such regular planned maintenance been carried out, the system would probably have been operational at the time of the fire.

The PMS required frequent checks of all components – from the bottle pressures and pressure gauges, to the condition of the system pipework and operation of valves. However, no shipboard maintenance records could be located and, according to the crew, these had been destroyed in

²² Panama Maritime Authority Merchant Marine Circular MMC-281 'Guidelines²² for maintenance and inspection of the FFE'.

the fire. However, the ATSB investigators identified service agents' maintenance stickers in the Halon room. The stickers indicated that the system, including the bottles, had been checked 4 months before the fire. However, other stickers indicated that the maintenance of the pilot CO₂ bottle in the FCR was 2 years overdue and inspection of the pilot CO₂ bottle in the Halon room was 9 years overdue.

While it is unknown if the crewmembers had completed the required tests and inspections on the FFE, the multiple system failures and condition of some system components suggested that regular and effective maintenance attention had not been carried out.

Shore response

The Department of Fire and Emergency Services (DFES) is the hazard management agency (HMA) for any marine transport emergency (MTE) involving a fire that occurs in WA waters. As the HMA, it has overall responsibility for the control and coordination of the response, which is exercised through the incident controller (IC). The IC is in command of the overall operations at the incident scene.

In Port Hedland's port limits, PPA is the controlling agency for an MTE, and its role is to assist the HMA with marine expertise and response coordination. The role of BHP Billiton, the maritime export facility owner, is to initially provide the IC.

Incident controller

After *Marigold's* master reported the fire to Port Hedland's SCT, the duty VTSO initiated the emergency call out procedure as per the PPA's ERP.

In response, BHP Billiton mobilised its duty response team. The senior ESO arrived on the scene first and assumed the role of IC. Therefore, BHP Billiton was the lead combat agency at this time (in accordance with the ERP). Shortly after, two South Hedland VFRS firefighters arrived at the berth, and the senior firefighter relieved the ESO as IC. Subsequently, when the ESS arrived at the berth, he received a handover from the senior firefighter before assuming the IC role.

At that time, the DFES acting area officer (AO) was travelling from Karratha to Port Hedland. He contacted the SCT and advised that as IC, he was directing that no one enter the ship's engine room. Shortly after, a VFRS firefighter took a phone call from the AO, which he transferred to the IC at the scene. The AO then issued instructions to seal the engine room and monitor temperatures.

When the AO arrived on the scene some time later, the IC briefed him. However, the AO did not take control of the incident.

At about 1800, the ESOs reported that the fire appeared to be smouldering and temperatures were reducing. The ESS, ESOs and others then expected to make an entry into the engine room. However, the AO advised the ESS (still in the IC role) and PPA that he would not allow entry to the engine room until three consecutive measured temperature reductions were recorded.

It was not until 2004 on 13 July that the AO took over as IC from the ESS.

Recounting their experiences after the emergency, the representatives of each agency noted that command and control arrangements had been confused in the initial hours. Significant matters pointed out included the following:

- PPA assumed that the DFES AO was the IC after he issued instructions to seal the engine room and monitor temperatures while still en route to Port Hedland.
- BHP Billiton's ESS briefed the AO when he arrived at the scene. However, instead of assuming the IC role, he indicated that DFES could take control of the incident at any point in time. Yet the AO continued issuing orders while the ESS was still in the IC role.
- DFES felt that in the initial stages there appeared to be two ICs (from PPA and BHP Billiton).

- At 2004, when the AO officially assumed the IC role, he did not receive a formal handover from the ESS.
- PPA did not declare an ‘incident level’ for the emergency, as required by its ERP.

Despite the inter-agency agreements, arrangements and emergency plans, it was evident that there were misunderstandings with respect to the role of each agency in the early stages of the incident. Their emergency plans did not define trigger points for the transfer of control or include adequate instructions on formal hand over of responsibilities during incident response. Further, there were inconsistencies between individual emergency plans with respect to a multi-agency response, and command and control arrangements.

First responders checklist

The DFES provided its first response fire services in regional ports with a ‘ship firefighting cache’. The cache contained the marine fire emergency response guide (MFERG), which included the ‘Ship fire response checklist’. The checklist provided guidance for establishing firefighting strategies and recording incident information.

In Port Hedland, the ship firefighting cache was located at the local fire station. However, the designated multi-agency first responders (BHP Billiton and South Hedland VFRS) did not have a copy of the MFERG.

The ship firefighting cache was stowed with the VFS firefighter’s machinery and equipment. The large size of the cache resulted in the VFS firefighter having difficulties loading it into the Port Hedland fire appliance, which delayed his arrival at the berth. Further, once he had arrived with the cache, no one used the MFERG.

The ESS used BHP Billiton’s ‘Tactical response plan for shipboard fires’. The content of the checklist/s in this plan was different to that of the MFERG checklist. Therefore, each party would have been unfamiliar with the others’ process, particularly if used to handover the IC role.

It would have been prudent for all agencies to be completely familiar with the MFERG checklist. Each agency would then have been able to work with the same guidance to manage the MTE.

On 13 July, the ‘Ship fire response checklist’ could have been started by the first IC and then accurately maintained by each successive IC. This would have assisted in removing ambiguities and confusion throughout the emergency response and enabled appropriate IC handovers.

International shore connection

The DFES directive for land-based marine firefighting required a connection to the international shore coupling²³ to be established as soon as possible. Connection of the land-based fire hose to a ship’s fire hydrant allows a water supply to its fire main. Each ship firefighting cache required an international shore connection.

Further, SOLAS regulations²⁴ require all ships of 500 gross tons and over to have an international shore connection on board. Therefore, a connection should always be available.

When the first responders arrived at the berth, ESO’s ran fire hoses from a shore fire hydrant. A South Hedland VFRS firefighter noted that an international shore connection was not connected to the shipboard end of a fire hose. However, ESO’s and firefighters continued connecting lengths of hose, which were then passed up onto the ship. The hose was connected to a ‘Y’ branch that fed two hoses, one of which the ESO’s used to enter the steering gear room. The insufficient length of the hose limited their access and movement.

²³ An international shore connection consists of a standard flange that is fitted to the ship’s fire main. It allows land based fire services hose to supply the ship’s fire main. The ship’s part of the international shore connection also has a flange. Once the flanges have been bolted together, fire service pumps can supply water to the ship’s fire main.

²⁴ SOLAS 1981 Chapter II-2, Regulation 19

Most regional areas in WA, including Port Hedland, have low mains water pressure. Therefore, had the shore responders utilised an international shore connection, a relay pump system could have been provided using the fire engines in attendance. The shore hoses would then have pressurised the ships fire main and hydrants (and hoses) in locations near the fire could have been utilised. This would have increased the firefighting capacity and the options for a defensive or offensive strategy.

Firefighting tugs

The PPA ERP provides the following guidance for tug deployment to fight a shipboard fire at a berth:

The Harbour Master will deploy firefighting tugs to assist with firefighting and to protect vessels or other interests in the port. The local VFSR officer will be on board a tug directing fire-fighting operations, while the operational control of the tug remains with the tug master.

However, a VFRS officer was not available on 13 July, as both South Hedland VFRS firefighters were assisting the IC on the berth. Meanwhile, the Port Hedland VFS was transporting the ship firefighting cache to the berth. Consequently, when the harbour master mobilised firefighting tugs, there was no DFES firefighter on board a tug to direct firefighting operations.

Firefighting capabilities in Port Hedland

At the time of the fire, the DFES firefighting capability in Port Hedland consisted of volunteer firefighters: one on duty in Port Hedland (VFS) and two in South Hedland (VFRS). Professional firefighters were stationed in Karratha, about 245 km away, and specialised firefighters (ship entry) in Perth, about 1,650 km away.

In the initial stages of the incident response, only the three volunteer firefighters attended the scene. It is evident that this number of available firefighters in the port could not effectively respond in accordance with agreed emergency plans.

Further, the AO declined the ESO's suggestion to make an entry into the engine room on the basis that that he required three consecutive temperature reductions before allowing entry. However, had this condition been met and entry was possible, the DFES had no MFASC (ship entry) firefighters on scene to make such entry. It was not until about 24 hours after the fire had started that the Perth-based MFASC brigade arrived on the scene.

The lack of professional firefighters in the area restricted firefighting strategies for tackling shipboard fires in Port Hedland. While MFASC firefighters are trained and equipped to enter confined spaces and suppress fires, volunteer firefighters are trained to contain the fire until additional expertise is available. MFASC firefighters are required for offensive attacks, such as may be required if the ships fixed fire suppression system has been exhausted, or to rescue personnel. Without any MFASC firefighters immediately available, the initial strategy by the first responders would be defensive - regardless of the situation or the need for rescue.

Access control

The DFES procedures required the ship's engine room and the accommodation atmosphere to be tested to determine the level of post-fire toxins and to provide advice regarding PPE requirements.

The tests measured levels of oxygen (O₂), hydrogen sulphide (H₂S), carbon monoxide (CO), flammable gases (LEL) and volatile organic compounds (VOC).

The photo ionisation detector (PID) required to test VOCs was normally stored in Karratha. However, at the time of the incident, the Karratha-based professional firefighters were not aware that the PID was in Perth for routine maintenance. This delayed the testing, as an operational PID needed to be air freighted from Perth.

At 2035 on 15 July, DFES officers completed the testing. The O₂, H₂S, CO and LEL levels were at normal and safe levels. However, the VOCs throughout the ship were above the permissible exposure limits.

Consequently, DFES provided the harbour master with the following advice:

- residential decks not suitable for long term exposure (greater than 4 hours)
- respiratory masks to be worn
- disposable overalls to be worn
- gloves to be worn
- maintain a hygiene station with soap and water
- continue mechanical ventilation.

However, during the time from when the fire started and the atmospheric tests were completed, numerous personnel accessed the ship and spaces within it. These personnel had not been provided with any guidance about hazardous areas or PPE requirements. Further, most crewmembers had slept on board overnight – many of them inside the affected accommodation.

The delay in atmospheric testing meant that anyone who was on board during the 53 hours after the fire started had been potentially exposed to unmitigated, hazardous conditions.

Findings

From the evidence available, the following findings are made with respect to the engine room fire on board *Marigold* while the ship was loading cargo in Port Hedland, Western Australia on 13 July 2014. These findings should not be read as apportioning blame or liability to any particular organisation or individual.

Safety issues, or system problems, are highlighted in bold to emphasise their importance.

A safety issue is an event or condition that increases safety risk and (a) can reasonably be regarded as having the potential to adversely affect the safety of future operations, and (b) is a characteristic of an organisation or a system, rather than a characteristic of a specific individual, or characteristic of an operating environment at a specific point in time

Contributing factors

- At about 1447 on 13 July 2014, a fire started on *Marigold's* number 1 diesel generator after a fuel oil pressure gauge compression fitting failed. Pressurised fuel oil escaping from the fitting then ignited after it came in contact with a sufficiently hot surface on the generator.
- The compression fitting that failed had been used to connect a replacement pressure gauge that had a different pipe connection fitting size to the original pressure gauge.
- **A number of *Marigold's* engine room fire doors were held open by wire and/or rope. The open doors allowed the smoke to spread across the engine room and into the accommodation spaces. [Safety issue]**
- **The maintenance of the opening/closing arrangements for *Marigold's* engine room fire dampers, ventilators and other openings was inadequate. A number of these could not be closed, resulting in the inability to seal the engine room to contain and suppress the fire. [Safety Issue]**
- ***Marigold's* Halon gas fixed fire suppression system for the engine room was not fully operational. The multiple failures of the system at the time of the fire were not consistent with proper maintenance and testing. [Safety Issue]**
- ***Marigold's* shipboard procedures for crew induction, familiarisation, fire drills and safety training were not effectively implemented. As a result, the ship's senior officers were not sufficiently familiar with the Halon system's operation. They did not identify its partial failure and did not activate the override function. [Safety Issue]**

Other factors that increased risk

- **Port Hedland's emergency response teams did not use the ship's international shore fire connection. As a result, *Marigold's* fire main was not pressurised with water from ashore. [Safety Issue]**
- **The emergency response plans for a ship fire in Port Hedland did not clearly define transfer of control procedures for successive incident controllers from different organisations or contain standard checklists for their use. [Safety Issue]**
- **The large size and weight of the ship firefighting cache made it difficult for the duty Port Hedland volunteer firefighter to transport it to the wharf. [Safety Issue]**
- Shutting down *Marigold's* emergency generator cut power to the ship's fire pump and systems and reduced the available firefighting resources and capacity.
- Contrary to the ship's procedures and accepted safe practice, some crewmembers used the lift to evacuate the engine room after the fire started.

- **Suitable atmospheric testing equipment was not available in Port Hedland to ensure safe entry to fire-affected spaces on board *Marigold*. Access to these areas was not controlled until 53 hours after the fire. [Safety Issue]**
- **The limited professional firefighting capability in Port Hedland restricted the ability to launch an effective response to the fire on board *Marigold*. [Safety Issue]**

Safety issues and actions

The safety issues identified during this investigation are listed in the Findings and Safety issues and actions sections of this report. The Australian Transport Safety Bureau (ATSB) expects that all safety issues identified by the investigation should be addressed by the relevant organisation(s). In addressing those issues, the ATSB prefers to encourage relevant organisation(s) to proactively initiate safety action, rather than to issue formal safety recommendations or safety advisory notices.

All of the directly involved parties were provided with a draft report and invited to provide submissions. As part of that process, each organisation was asked to communicate what safety actions, if any, they had carried out or were planning to carry out in relation to each safety issue relevant to their organisation.

The initial public version of these safety issues and actions are repeated separately on the ATSB website to facilitate monitoring by interested parties. Where relevant the safety issues and actions will be updated on the ATSB website as information comes to hand.

Fire doors

Number:	MO-2014-008-SI-01
Issue owner:	Korea Leading Company of Ship Management (KLCSM)
Operation affected:	Marine: Shipboard operations
Who it affects:	All persons responsible for the maintenance of equipment

Safety issue description:

A number of *Marigold's* engine room fire doors were held open by wire and/or rope. The open doors allowed the smoke to spread across the engine room and into the accommodation spaces.

Proactive safety action taken by Korea Leading Company of Ship Management (KLCSM)

Action number: MO-2014-008-NSA-001

All KLCSM ships are now required to have signs on fire doors requiring the doors to be kept closed. The company's superintendents will inspect each ship for compliance with this procedure and the condition of each fire door. It has also committed to providing fire prevention and response training to all crewmembers across the fleet.

Current status of the safety issue

Issue status: Adequately addressed

Justification: Proactive safety action taken.

Ventilation closedown

Number:	MO-2014-008-SI-02
Issue owner:	Korea Leading Company of Ship Management (KLCSM)
Operation affected:	Marine: Shipboard operations
Who it affects:	All persons responsible for the maintenance of equipment

Safety issue description:

The maintenance of the opening/closing arrangements for *Marigold's* engine room fire dampers, ventilators and other openings was inadequate. A number of these could not be closed, resulting in the inability to seal the engine room to contain and suppress the fire.

Proactive safety action taken by KLCSM

Action number: MO-2014-008-NSA-002

The company has committed resources to inspect all fire dampers and ventilators on board its ships. These inspections are intended to identify any defects and the condition of each damper/ventilator. Defective equipment is to be repaired or replaced. The company has also amended its planned maintenance system with enhanced checks for opening and closing mechanisms of ventilators and dampers. Additionally, KLCSM has committed to providing training that focuses on fixed fire extinguishing systems to all crewmembers across its fleet.

Current status of the safety issue

Issue status: Adequately addressed

Justification: Proactive safety action taken.

Fixed fire suppression system

Number:	MO-2014-008-SI-03
Issue owner:	Korea Leading Company of Ship Management (KLCSM)
Operation affected:	Marine: Shipboard operations
Who it affects:	All persons responsible for the maintenance of equipment

Safety issue description:

Marigold's Halon gas fixed fire suppression system for the engine room was not fully operational. The multiple failures of the system at the time of the fire were not consistent with proper maintenance and testing.

Proactive safety action taken by KLCSM

Action number: MO-2014-008-NSA-003

The company has updated its planned maintenance system with amended checks and increased frequency for inspecting the main distribution valves of fixed fire suppression systems.

ATSB comment/action in response:

The ATSB acknowledges the safety action taken by KLCSM to increase the frequency of inspecting fixed fire suppression system distribution valves. However, the checks and inspection routines that were in place at the time of the fire had failed to detect the issues that resulted in the multiple failures of *Marigold's* Halon system. This indicates that KLCSM's procedures for equipment maintenance and crew knowledge/training in this regard require a thorough review. The ATSB has issued the following recommendation to KLCSM.

ATSB safety recommendation to KLCSM

Action number: MO-2014-008-SR-035

Action status: Released

The ATSB recommends that KLCSM takes action to address the safety issue with regard to the maintenance of ships' fixed fire suppression systems to ensure they are fully operational at all times.

Current status of the safety issue

Issue status: Partially addressed

Justification: Further safety action by KLCSM with regard to the maintenance of ships' fixed fire suppression systems to ensure they are fully operational at all times is necessary to adequately address this issue.

Halon system

Number:	MO-2014-008-SI-04
Issue owner:	Korea Leading Company of Ship Management (KLCSM)
Operation affected:	Marine: Shipboard operations
Who it affects:	All persons responsible for the maintenance of equipment

Safety issue description:

Marigold's shipboard procedures for crew induction, familiarisation, fire drills and safety training were not effectively implemented. As a result, the ship's senior officers were not sufficiently familiar with the Halon system's operation. They did not identify its partial failure and did not activate the override function.

Proactive safety action taken by KLCSM

Action number: MO-2014-008-NSA-004

The company has committed to providing training that focuses on fixed fire extinguishing systems to all crewmembers across its fleet.

Current status of the safety issue

Issue status: Adequately addressed

Justification: Proactive safety action taken.

International shore connection

Number:	MO-2014-008-SI-05
Issue owner:	BHP Billiton and Department of Fire and Emergency Services (DFES)
Operation affected:	Marine: Shore-based operations
Who it affects:	All persons charged with shipboard firefighting

Safety issue description:

Port Hedland's emergency response teams did not use the ship's international shore fire connection. As a result, *Marigold's* fire main was not pressurised with water from ashore.

Proactive safety action taken by BHP Billiton

Action number: MO-2014-008-NSA-005

BHP Billiton advised the ATSB that it does not consider pressurisation of *Marigold's* fire main line was relevant to the incident response. However, it has taken safety action by ordering a number of international shore fire connections for use at its wharves.

ATSB comment in response

The ATSB acknowledges the proactive action taken by BHP Billiton.

Response to safety issue by DFES

The DFES did not make a submission.

ATSB safety recommendation to DFES

Action number: MO-2014-008-SR-037

Action status: Released

The ATSB recommends that the Department of Fire and Emergency Services (DFES) takes action to address the safety issue regarding the appropriate use of international shore connections to pressurise ship fire mains when responding to shipboard fires.

Current status of the safety issue

Issue status: Partially addressed

Justification: Safety action by DFES is necessary to complement the proactive action taken by BHP Billiton, and to ensure the appropriate use of international shore connections to pressurise ship fire mains when responding to shipboard fires.

Incident control

Number:	MO-2014-008-SI-06
Issue owner:	BHP Billiton, Pilbara Ports Authority and Department of Fire and Emergency Services (DFES)
Operation affected:	Marine: Shore-based operations
Who it affects:	All agencies charged with shipboard firefighting

Safety issue description:

The emergency response plans for a ship fire in Port Hedland did not clearly define transfer of control procedures for successive incident controllers from different organisations or contain standard checklists for their use.

Proactive safety action taken by BHP Billiton

Action number: MO-2014-008-NSA-006

BHP Billiton advised the ATSB that its Crisis Emergency Management procedure outlines the Department of Fire and Emergency Services (DFES) role as the hazard management agency and contains trigger points for incident controller handovers. Additionally, standardised checklists (aligned to DFES checklists) are to be incorporated into its emergency response plan for marine incidents involving shipboard fires.

ATSB comment in response

The ATSB acknowledge the proactive action taken by BHP Billiton.

Response to safety issue by Pilbara Ports Authority

The Pilbara Ports Authority advised the ATSB that as a result of the *Marigold* and another recent shipboard fire in Western Australia, the State’s plan for managing maritime transport emergencies has been revised. The revised plan includes formal incident controller delegations.

ATSB comment in response

The ATSB notes that Western Australia’s plan for managing maritime transport emergencies has been revised to include formal incident controller delegations.

Response to safety issue by DFES

The DFES did not make a submission.

ATSB safety recommendation to DFES

Action number: MO-2014-008-SR-040

Action status: Released

The ATSB recommends that the Department of Fire and Emergency Services (DFES) takes action to address the safety issue regarding the transfer of control procedures for incident controllers from different organisations.

Current status of the safety issue

Issue status: Partially addressed

Justification: Safety action by DFES is necessary to complement the proactive action taken by BHP Billiton, and to ensure clearly defined transfer of control procedures for incident controllers from different organisations.

Access control

Number:	MO-2014-008-SI-07
Issue owner:	Department of Fire and Emergency Services (DFES)
Operation affected:	Marine: Shore-based operations
Who it affects:	All agencies charged with shipboard firefighting in regional ports

Safety issue description:

Suitable atmospheric testing equipment was not available in Port Hedland to ensure safe entry to fire-affected spaces on board *Marigold*. Access to these areas was not controlled until 53 hours after the fire.

Response to safety issue by DFES

The DFES did not make a submission.

ATSB safety recommendation to DFES

Action number: MO-2014-008-SR-041

Action status: Released

The ATSB recommends that the Department of Fire and Emergency Services (DFES) takes action to address the safety issue regarding the safe access to fire and smoke-affected shipboard spaces.

Current status of the safety issue

Issue status: Not addressed

Justification: Safety action by DFES is necessary to ensure safe access to fire and smoke-affected shipboard spaces.

Professional firefighters in Port Hedland

Number:	MO-2014-008-SI-08
Issue owner:	Department of Fire and Emergency Services (DFES)
Operation affected:	Marine: Shore-based operations
Who it affects:	All agencies charged with shipboard firefighting

Safety issue description:

The limited professional firefighting capability in Port Hedland restricted the ability to launch an effective response to the fire on board *Marigold*.

Response to safety issue by DFES

The DFES did not make a submission.

ATSB safety recommendation to DFES

Action number: MO-2014-008-SR-042

Action status: Released

The ATSB recommends that the Department of Fire and Emergency Services (DFES) takes action to address the safety issue regarding the limited professional firefighting capability in Port Hedland and other regional ports.

Current status of the safety issue

Issue status: Not addressed

Justification: Safety action by DFES is necessary to ensure adequate professional firefighting capability in Port Hedland and other regional ports.

Ship firefighting cache

Number:	MO-2014-008-SI-09
Issue owner:	Department of Fire and Emergency Services (DFES)
Operation affected:	Marine: Shore-based operations
Who it affects:	All agencies charged with shipboard firefighting

Safety issue description:

The large size and weight of the ship firefighting cache made it difficult for the duty Port Hedland volunteer firefighter to transport it to the wharf.

Response to safety issue by DFES

The DFES did not make a submission.

ATSB safety recommendation to DFES

Action number: MO-2014-008-SR-043

Action status: Released

The ATSB recommends that the Department of Fire and Emergency Services (DFES) takes action to address the safety issue regarding the transportation of ship firefighting caches to wharves.

Current status of the safety issue

Issue status: Not addressed

Justification: Safety action by DFES is necessary to ensure that ship firefighting caches can be expediently transported to wharves.

General details

Occurrence details

Date and time:	13 July 2014 – 1447, UTC + 8 hours	
Occurrence category:	Serious Incident	
Primary occurrence type:	Fire	
Location:	Finucane Island B berth, Port Hedland, Western Australia	
	Latitude: 20° 19' S	Longitude: 118° 34' E

Ship details

Name:	<i>Marigold</i>
IMO number:	8815255
Call sign:	3FEE7
Flag:	Panama
Classification society:	Korean Register of Shipping (KR)
Ship type:	Bulk carrier
Builder:	Hyundai Heavy Industries, Ulsan, South Korea
Year built:	1990
Owner(s):	Tiger United SA, South Korea
Manager:	Korea Leading Company of Ship Management (KLCSM), South Korea
Gross tonnage:	110,779
Deadweight (summer):	207,250
Summer draught:	18.019 m
Length overall:	309.0 m
Moulded breadth:	50.00 m
Moulded depth:	25.70 m
Main engine(s):	B&W 6L80MCE
Total power:	12,181 kW (16,561 hp) at 72 rpm
Speed:	14.80 knots
Damage:	Significant damage to the generators, electrical system, wiring and switchboards throughout the engine room and engine control room.

Sources and submissions

Sources of information

The sources of information during the investigation included:

- *Marigold's* master and directly involved crewmembers
- Port Hedland's harbour master and shipping superintendent
- Port Hedland Pilots
- BHB Billiton marine manager and emergency services supervisors
- The Korean Register of Shipping.

References

Government of Western Australia, Department of Transport, Western Australia, *Port Authorities Act 1999 (WA)*, WADOT, Perth. Available from <www.transport.wa.gov.au>

Government of Western Australia, Department of Fire and Emergency Services, 2013, *Marine Fire Emergency Response Guide*, WADFES, Perth.

Government of Western Australia, Department of Fire and Emergency Services, 2013, *Directive 3.18 Land Based Marine Firefighting*, WADFES, Perth.

Government of Western Australia, Department of Fire and Emergency Services, 2014, *Marine Firefighting – Learners Manual*, WADFES, Perth.

Government of Western Australia, Department of Transport, Western Australia, 2011, *State Emergency Management Plan for Marine Transport Emergency (WESTPLAN – MTE)*, WADOT, Perth. Available from <www.semc.wa.gov.au>

Government of Western Australia, Department of Fire and Emergency Services, 2013, *State emergency management plan for fire (WESTPLAN – Fire)*, WADFES, Perth. Available from <www.semc.wa.gov.au>

International Maritime Organisation, 2015, *The International Convention for the Safety of Life at Sea (SOLAS) 1974*, as amended, IMO, London.

Port Hedland Port Authority, *Emergency Response Procedure*, Pilbara Port Authority. Available from <www.pilbaraports.com.au>

BHP Billiton Iron Ore, 2014, *Security & Emergency Management, Emergency Management Plan, Part 1 Version 2.0*, BHP Billiton.

BHP Billiton Iron Ore, 2014, *Health & Safety, Crisis and Emergency Management Version 2.0*, BHP Billiton.

Submissions

Under Part 4, Division 2 (Investigation Reports), Section 26 of the *Transport Safety Investigation Act 2003* (the Act), the Australian Transport Safety Bureau (ATSB) may provide a draft report, on a confidential basis, to any person whom the ATSB considers appropriate. Section 26 (1) (a) of the Act allows a person receiving a draft report to make submissions to the ATSB about the draft report.

A draft of this report was provided to:

- *Marigold's* master and directly involved crewmembers
- the Korea Leading Company of Ship Management

- Port Hedland's harbour master and shipping superintendent
- Port Hedland Pilots
- BHB Billiton marine manager and emergency services supervisors
- Department Fire and Emergency Services (DFES) Superintendent
- Australian Maritime Safety Authority.

Submissions were received from:

- the Korea Leading Company of Ship Management
- Port Hedland's harbour master and shipping superintendent
- BHB Billiton marine manager
- Australian Maritime Safety Authority.

The submissions were reviewed and where considered appropriate, the text of the report was amended accordingly.

Australian Transport Safety Bureau

The Australian Transport Safety Bureau (ATSB) is an independent Commonwealth Government statutory agency. The ATSB is governed by a Commission and is entirely separate from transport regulators, policy makers and service providers. The ATSB's function is to improve safety and public confidence in the aviation, marine and rail modes of transport through excellence in: independent investigation of transport accidents and other safety occurrences; safety data recording, analysis and research; fostering safety awareness, knowledge and action.

The ATSB is responsible for investigating accidents and other transport safety matters involving civil aviation, marine and rail operations in Australia that fall within Commonwealth jurisdiction, as well as participating in overseas investigations involving Australian registered aircraft and ships. A primary concern is the safety of commercial transport, with particular regard to fare-paying passenger operations.

The ATSB performs its functions in accordance with the provisions of the *Transport Safety Investigation Act 2003* and Regulations and, where applicable, relevant international agreements.

Purpose of safety investigations

The object of a safety investigation is to identify and reduce safety-related risk. ATSB investigations determine and communicate the factors related to the transport safety matter being investigated.

It is not a function of the ATSB to apportion blame or determine liability. At the same time, an investigation report must include factual material of sufficient weight to support the analysis and findings. At all times the ATSB endeavours to balance the use of material that could imply adverse comment with the need to properly explain what happened, and why, in a fair and unbiased manner.

Developing safety action

Central to the ATSB's investigation of transport safety matters is the early identification of safety issues in the transport environment. The ATSB prefers to encourage the relevant organisation(s) to initiate proactive safety action that addresses safety issues. Nevertheless, the ATSB may use its power to make a formal safety recommendation either during or at the end of an investigation, depending on the level of risk associated with a safety issue and the extent of corrective action undertaken by the relevant organisation.

When safety recommendations are issued, they focus on clearly describing the safety issue of concern, rather than providing instructions or opinions on a preferred method of corrective action. As with equivalent overseas organisations, the ATSB has no power to enforce the implementation of its recommendations. It is a matter for the body to which an ATSB recommendation is directed to assess the costs and benefits of any particular means of addressing a safety issue.

When the ATSB issues a safety recommendation to a person, organisation or agency, they must provide a written response within 90 days. That response must indicate whether they accept the recommendation, any reasons for not accepting part or all of the recommendation, and details of any proposed safety action to give effect to the recommendation.

The ATSB can also issue safety advisory notices suggesting that an organisation or an industry sector consider a safety issue and take action where it believes it appropriate. There is no requirement for a formal response to an advisory notice, although the ATSB will publish any response it receives.

Australian Transport Safety Bureau

Enquiries 1800 020 616

Notifications 1800 011 034

REPCON 1800 011 034

Web www.atsb.gov.au

Twitter @ATSBinfo

Email atsbinfo@atsb.gov.au

Facebook [atsbgovau](https://www.facebook.com/atsbgovau)

Investigation

ATSB Transport Safety Report

Engine room fire on board the bulk carrier Marigold
Port Hedland, Western Australia 13 July 2015

312-MO-2014-008

Final – 20 April 2016