



Australian Government

Australian Transport Safety Bureau

ATSB TRANSPORT SAFETY REPORT

Aviation Occurrence Investigation – AO-2009-012
Interim Factual Report

Tailstrike
Melbourne Airport, Vic.
20 March 2009
A6-ERG
Airbus A340-541



Australian Government

Australian Transport Safety Bureau

ATSB TRANSPORT SAFETY REPORT
Aviation Occurrence Investigation
AO-2009-012
Interim Factual Report

Tailstrike
Melbourne Airport, Vic.
20 March 2009
A6-ERG
Airbus A340-541

Released in accordance with section 25 of the *Transport Safety Investigation Act 2003*

Published by: Australian Transport Safety Bureau
Postal address: PO Box 967 Civic Square ACT 2608
Office location: 62 Northbourne Ave, Canberra City, Australian Capital Territory, 2601
Telephone: 1800 020 616, from overseas +61 2 6257 4150
Accident and incident notification: 1800 011 034 (24 hours)
Facsimile: 02 6247 3117, from overseas +61 2 6247 3117
Email: atsbinfo@atsb.gov.au
Internet: www.atsb.gov.au

© Commonwealth of Australia 2009.

This work is copyright. In the interests of enhancing the value of the information contained in this publication you may copy, download, display, print, reproduce and distribute this material in unaltered form (retaining this notice). However, copyright in the material obtained from other agencies, private individuals or organisations, belongs to those agencies, individuals or organisations. Where you want to use their material you will need to contact them directly.

Subject to the provisions of the *Copyright Act 1968*, you must not make any other use of the material in this publication unless you have the permission of the Australian Transport Safety Bureau.

Please direct requests for further information or authorisation to:

Commonwealth Copyright Administration, Copyright Law Branch
Attorney-General's Department, Robert Garran Offices, National Circuit, Barton, ACT 2600
www.ag.gov.au/cca

ISBN and formal report title: see 'Document retrieval information' on page v

CONTENTS

THE AUSTRALIAN TRANSPORT SAFETY BUREAU	vi
FACTUAL INFORMATION	1
History of the flight.....	1
Pre-flight preparation.....	2
Injuries to persons	3
Damage to the aircraft.....	3
Other damage	6
Personnel information	10
Captain.....	10
First officer	10
Augmenting flight crew.....	10
Flight crew trip history	12
Flight time limitations	13
Application of flight crew fatigue models	13
Aircraft information	14
General	14
Engines	15
High lift devices	15
Design operating crew	16
Flight management and guidance system.....	16
Aircraft tailstrike limit.....	20
Weight and Balance.....	21
Meteorological information	22
Aerodrome forecasts.....	22
Actual weather information	22
Aids to navigation	23
Aerodrome information	23
Flight recorders	24
Overview	24
Recording system operation	24
Flight recorder retrieval	25
Flight recorder download	25
Sequence of events	26

Other information	27
Reduced thrust takeoffs	27
Airbus Less Paper Cockpit electronic flight bag system	28
Similar take-off performance-related occurrences	30
ONGOING INVESTIGATION ACTIVITIES	31
SAFETY ACTION	33
Aircraft operator	33
Aircraft manufacturer.....	34
Australian Transport Safety Bureau.....	34
APPENDIX A: GRAPHICAL REPRESENTATION OF FLIGHT DATA	35
APPENDIX B: KEY EVENT SNAPSHOTS	37
APPENDIX C: AIRBUS TAKE-OFF SECURING FUNCTION	41
APPENDIX D: MEDIA RELEASE	50
Tailstrike at Melbourne Airport, Vic. on 20 March 2009 – Interim Factual report.....	50

DOCUMENT RETRIEVAL INFORMATION

Report No.	Publication date	No. of pages	ISBN
AO-2009-012	18 December 2009	58	978-1-74251-014-9

Publication title

Tailstrike - Melbourne Airport, Vic. - 20 March 2009 - A6-ERG, Airbus A340-541

Prepared By

Australian Transport Safety Bureau
PO Box 967, Civic Square ACT 2608 Australia
www.atsb.gov.au

Reference Number

Dec09/ATSB40

Acknowledgements

Figure 8: Background image courtesy of Google Earth
Figures 14, 15, 16, 17, 18, 21, 22, 24, and 25: Sourced from the operator's *Flight Crew Operating Manual*, Volume 1, (Document No. DOC2007/32, rev. 25) courtesy of the operator and Airbus.
Figures 27 and 28: Sourced from the operator's *Flight Crew Operating Manual*, Volume 2, (Document No. DOC2008/20, rev 30) courtesy of the operator and Airbus.
Figures 19 and 20: Sourced from the operator's *Flight Crew Operating Manual*, Volume 4, (Document No. DOC2008/18, rev 21) courtesy of the operator and Airbus.
Figure 23: From the operator's *FCOM Bulletin No. 807/1*, courtesy of the operator and Airbus.

Abstract

On 20 March 2009, at 2230:49 Eastern Daylight-saving Time (1130:49 UTC), an Airbus A340-541 aircraft, registered A6-ERG, commenced the take-off roll on runway 16 at Melbourne Airport, Vic. on a scheduled 14-hour passenger flight to Dubai, United Arab Emirates (UAE). Onboard the aircraft (operating as flight number EK407) were 257 passengers, 14 cabin crew and 4 flight crew.

During the reduced thrust takeoff, the aircraft's tail made contact with the runway surface, but the aircraft did not begin to climb. The captain commanded and selected take-off and go-around engine thrust and the aircraft commenced a climb. After jettisoning fuel to reduce the landing weight, the flight crew returned the aircraft to Melbourne for landing.

The investigation has determined that the pre-flight take-off performance calculations were based on an incorrect take-off weight that was inadvertently entered into the take-off performance software on a laptop computer used by the flight crew. Subsequent crosschecks did not detect the incorrect entry and its effect on performance planning.

As a result of this accident, the aircraft operator has undertaken a number of procedural, training and technical initiatives across its fleet and operations with a view to minimising the risk of a recurrence. In addition, the aircraft manufacturer has released a modified version of its performance-planning tool and is developing a software package that automatically checks the consistency of the flight data being entered into the aircraft's flight computers by flight crews.

The investigation has found a number of similar take-off performance-related incidents and accidents around the world. As a result, the Australian Transport Safety Bureau (ATSB) has initiated a safety research project to examine those events. The findings of that project will be released by the ATSB once completed. In the interim, the ATSB has drawn this interim report to the attention of relevant Australian operators to highlight the risks when calculating and checking take-off performance information. The investigation is continuing.

THE AUSTRALIAN TRANSPORT SAFETY BUREAU

The Australian Transport Safety Bureau (ATSB) is an independent Commonwealth Government statutory Agency. The Bureau is governed by a Commission and is entirely separate from transport regulators, policy makers and service providers.

The ATSB is responsible for investigating accidents and other transport safety matters involving civil aviation, marine and rail operations in Australia that fall within Commonwealth jurisdiction, as well as participating in overseas investigations involving Australian registered aircraft and ships. A primary concern is the safety of commercial transport, with particular regard to fare-paying passenger operations.

The ATSB performs its functions in accordance with the provisions of the *Transport Safety Investigation Act 2003* and Regulations and, where applicable, relevant international agreements.

Purpose of safety investigations

The object of a safety investigation is to enhance safety. To reduce safety-related risk, ATSB investigations determine and communicate the safety factors related to the transport safety matter being investigated.

It is not a function of the ATSB to apportion blame or determine liability. However, an investigation report must include factual material of sufficient weight to support the analysis and findings. At all times the ATSB endeavours to balance the use of material that could imply adverse comment with the need to properly explain what happened, and why, in a fair and unbiased manner.

Developing safety action

Central to the ATSB's investigation of transport safety matters is the early identification of safety issues in the transport environment. The ATSB prefers to encourage the relevant organisation(s) to proactively initiate safety action rather than release formal recommendations. However, depending on the level of risk associated with a safety issue and the extent of corrective action undertaken by the relevant organisation, a recommendation may be issued either during or at the end of an investigation.

When safety recommendations are issued, they will focus on clearly describing the safety issue of concern, rather than providing instructions or opinions on the method of corrective action. As with equivalent overseas organisations, the ATSB has no power to implement its recommendations. It is a matter for the body to which an ATSB recommendation is directed to assess the costs and benefits of any particular means of addressing a safety issue.

When the ATSB issues a safety recommendation, the person, organisation or agency must provide a written response within 90 days. That response must indicate whether the person, organisation or agency accepts the recommendation, any reasons for not accepting part or all of the recommendation, and details of any proposed safety action to give effect to the recommendation.

How investigation reports are organised and definitions of terms used in ATSB reports, such as safety factor, contributing safety factor and safety issue, are provided on the ATSB web site www.atsb.gov.au

FACTUAL INFORMATION

The information contained in this interim report is derived from the factual information gathered during the ongoing investigation of the occurrence – building upon the information presented in the preliminary report that was released to the public on 30 April 2009 (ISBN 978-1-921602-43-6). Readers are cautioned that there is the possibility that new evidence may become available that alters the circumstances as depicted in the report.

History of the flight

On 20 March 2009, at 2230:49 Eastern Daylight-saving Time¹ (1130:49 UTC) an Airbus A340-541 aircraft, registered A6-ERG, commenced the take-off roll on runway 16 at Melbourne Airport, Vic. on a scheduled 14-hour passenger flight to Dubai, United Arab Emirates (UAE). Onboard the aircraft (operating as flight number EK407) were 257 passengers, 14 cabin crew and 4 flight crew. The takeoff was planned as a reduced thrust takeoff² and the first officer was the handling pilot for the departure.

At 2231:53, the captain called for the first officer to rotate.³ The first officer attempted to rotate the aircraft, but it did not respond immediately with a nose-up pitch. The captain again called ‘rotate’ and the first officer applied a greater nose-up command. The nose of the aircraft was raised and the tail made contact with the runway surface, but the aircraft did not begin to climb. The captain then commanded and selected TOGA⁴ on the thrust levers, the engines responded immediately, and the aircraft commenced a climb.

After establishing a positive climb gradient, the crew noticed an ECAM⁵ message indicating that the aircraft had sustained a tailstrike. The flight crew notified air traffic control (ATC) of the tailstrike and that they would be returning the aircraft to Melbourne after jettisoning fuel. The aircraft was climbed to 7,000 ft and radar vectored by ATC for approximately 36 minutes over Port Phillip Bay while excess fuel was jettisoned to reduce the landing weight of the aircraft.

While reviewing the aircraft’s performance documentation in preparation for landing, the flight crew noticed that a take-off weight that was 100 tonnes below the actual take-off weight of the aircraft had inadvertently been used when completing the take-off performance calculation. The result of that incorrect take-off weight was to produce engine thrust settings and take-off reference speeds that were lower than those required for the aircraft’s actual weight.

¹ The 24-hour clock is used in this report to describe the local time of day, Eastern Daylight-saving Time (EDT), as particular events occurred. Eastern Daylight-saving Time was Coordinated Universal Time (UTC) + 11 hours.

² A reduced thrust takeoff is a takeoff carried out at less than maximum available engine thrust. Refer to the section of this report titled *Reduced thrust takeoffs* at page 27.

³ Raise the nose of the aircraft in order to become airborne.

⁴ TOGA: Take-off and go-around thrust setting, the maximum thrust that the engines will supply.

⁵ ECAM: Electronic Centralized Aircraft Monitoring. The ECAM provides information to the crew on the status of the aircraft and its systems.

At 2327, after completing the fuel jettison, and while configuring the aircraft to land on runway 34, the flight crew received a report from cabin crew in the rear of the aircraft of smoke in the cabin. The flight crew requested an immediate landing from ATC and commenced the approach.

At 2336, the aircraft landed and rolled to the runway end. The aircraft was examined by the airport fire and rescue services for signs of immediate danger; none were evident and the crew was provided a clearance by ATC to taxi the aircraft to the terminal where the passengers were disembarked.

Pre-flight preparation

The flight crew arrived at the aircraft at about 2120 and prepared the aircraft for departure. At 2153, the flight crew received the final load sheet⁶ via the Airborne Communication and Reporting System (ACARS)⁷ from the operator's head office. Shortly afterwards, the first officer completed the take-off performance calculations using the Airbus Less Paper Cockpit (LPC) electronic flight bag system⁸ and inadvertently inserted a take-off weight of 262.9 tonnes, instead of 362.9 tonnes, into the take-off weight field. The resultant figures were then recorded by the first officer on the operational flight plan before handing the LPC computer to the captain for cross-checking and the insertion of the results into the aircraft systems.

The captain then checked the take-off performance figures and entered the results into the flight management and guidance system through the captain's multi-purpose control and display unit. The captain's figures were cross-checked with the figures recorded by the first officer, and the LPC was then placed in standby mode and stowed.

The LPC-calculated take-off performance figures as recorded by the flight crew on the accident flight are shown in the first line of Table 1. Subsequent to the accident, the performance figures were recalculated by the investigation using one of the laptops from the aircraft and based on a take-off weight of 362.9 tonnes. The recalculated performance figures are shown in the second line of Table 1.

The pre-engine start checklists were completed and, at 2218, the aircraft was pushed back from the terminal gate, 7 minutes ahead of the scheduled departure time of 2225.

⁶ The load sheet was a document prepared by the operator detailing the aircraft's weight and balance based on the fuel, passenger and cargo loads for the particular flight. The load sheet contained information such as the zero fuel weight, take-off weight and landing weight.

⁷ The ACARS was a wireless communication system used to transmit and receive data to and from the aircraft. The aircraft also had a printer that was located between the flight crew in the centre console (Figure 17), and enabled ACARS messages to be printed.

⁸ The Airbus Less Paper Cockpit electronic flight bag system was a laptop computer-based software tool that included a function for calculating take-off performance. Refer to the section of this report titled *Airbus Less Paper Cockpit electronic flight bag system* at page 28.

Table 1: Take-off performance figures

Take-off Weight (tonnes) used in LPC Calculation	Configuration ⁹	Flex Temperature ¹⁰ (°C)	Take-off reference speeds (kts)		
			V ₁ ¹¹	V _R	V ₂
262.9 (accident)	1+F	74	143	145	154
362.9 (investigation)	3	43	149	161	173

Injuries to persons

Table 2: Number and level of injuries

Injuries	Crew	Passengers	Other	Total
Fatal	-	-	-	-
Serious	-	-	-	-
Minor	-	-	-	-
None	18	257	-	275
Total	18	257	-	275

Damage to the aircraft

An initial inspection of the aircraft revealed that the rear of the fuselage was seriously damaged¹². The lower skin panels were abraded by contact with the runway surface (Figure 1), and in some areas the skin had worn through the full thickness (Figure 2). A service panel had been dislodged (Figure 2) and was found by airport personnel at the end of the runway, along with numerous pieces of metal

⁹ Configuration of the aircraft's high-lift devices (leading edge slats and trailing edge flaps). Refer to the *High lift device discussion* and Figure 15 at page 15.

¹⁰ The flex temperature was an 'assumed temperature' used by the aircraft's computers to reduce the amount of thrust produced by the engines. Refer to the reduced thrust takeoff discussion at page 27.

¹¹ V₁: Decision speed, is the maximum speed at which a rejected takeoff can be initiated, in the event of an emergency.

V_R: Rotation Speed, is the speed at which rotation is initiated to ensure that, in the case of an engine failure, lift-off is possible and V₂ is reached at 35 feet (above ground level) at the latest.

V₂: Takeoff Safety Speed, is the minimum speed that needs to be maintained up to the acceleration altitude, in the event of an engine failure after V₁. Flight at V₂ ensures that the minimum required climb gradient is achieved, and that the aircraft is controllable.

'Airbus Flight Operations Briefing Notes – Takeoff and Departure Operations – Understanding Takeoff Speeds', retrieved on 9 April 2009 from: http://www.airbus.com/en/corporate/ethics/safety_lib

¹² The Australian Transport Safety Bureau classified this event as an accident. Consistent with the ICAO definition outlined in Annex 13 to the Chicago Convention, an accident is defined in the *Transport Safety Investigation Act 2003* as an investigable matter involving a transport vehicle where the vehicle is destroyed or seriously damaged.

consistent with the abraded skin panels. Numerous fuselage frames and stringers in the region were deformed and several contained cracks (Figure 3). The rear pressure bulkhead¹³ contained cracks in the composite structure and deformation of the diaphragm support ring (Figure 4). There were also scrapes on the right side of the fuselage consistent with contact with external objects. One contact mark had an orange colouration and was located forward of the skin abrasion, immediately below the right-rear cargo door (Figure 5). The other contact mark was located adjacent to the skin abrasion and consisted of several, fine, divergent marks running rearwards and slightly upwards (Figure 6). There was also a contact mark on the left main landing gear, inboard-rear tyre (Figure 7).

Figure 1: Skin abrasion

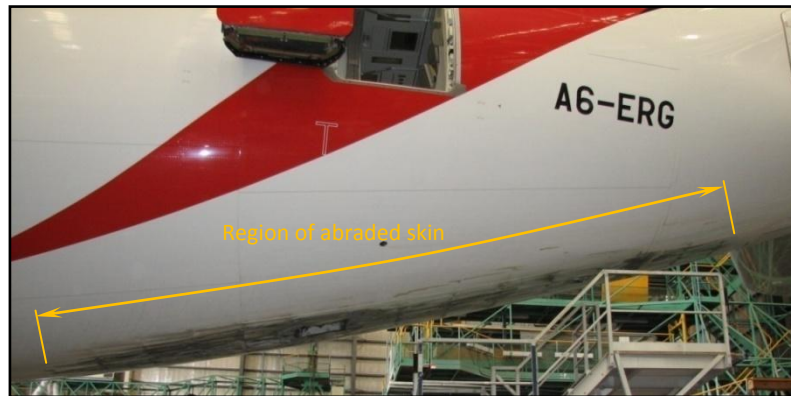
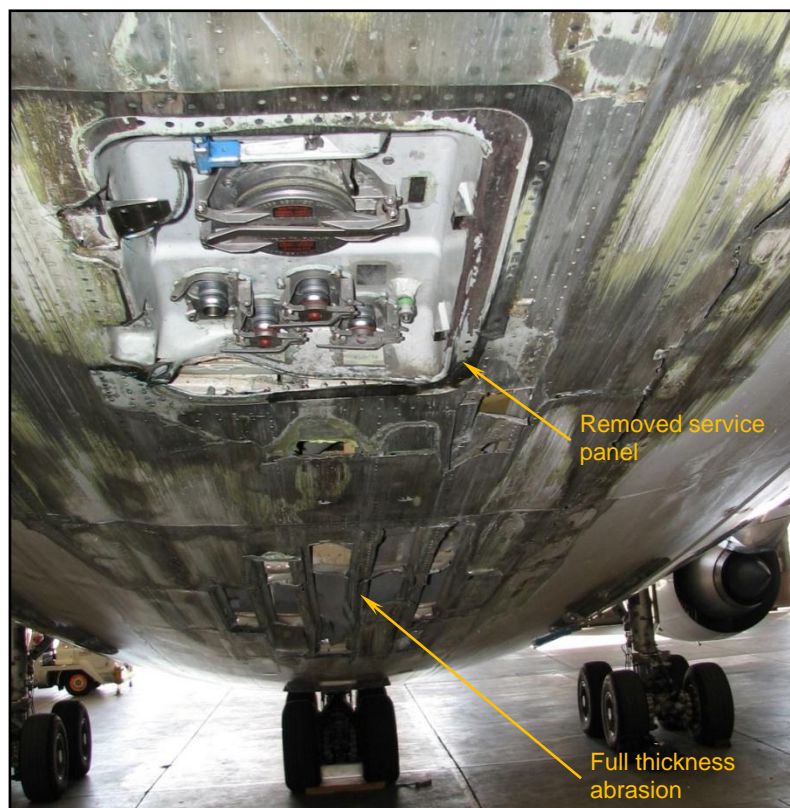

Figure 2: Skin abrasion detail



¹³ The rear pressure bulkhead is an airtight diaphragm that forms the rear pressure wall of the cabin.

Figure 3: Example of frame deformation and cracking

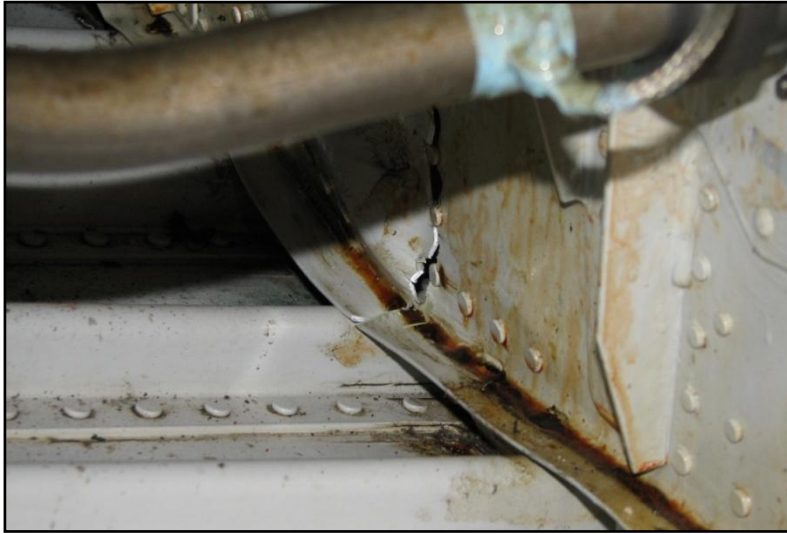

Figure 4: Example of rear pressure bulkhead damage

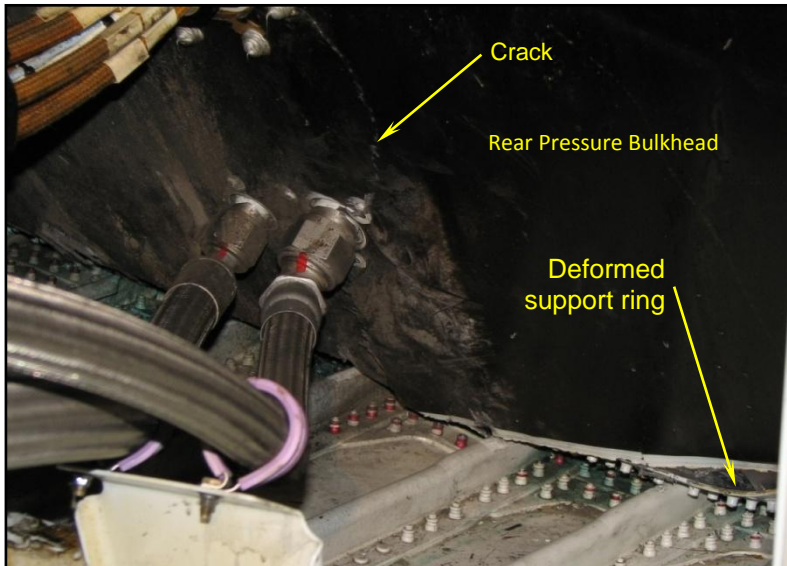

Figure 5: Contact mark below right, rear cargo door



Figure 6: Contact marks adjacent to skin abrasion

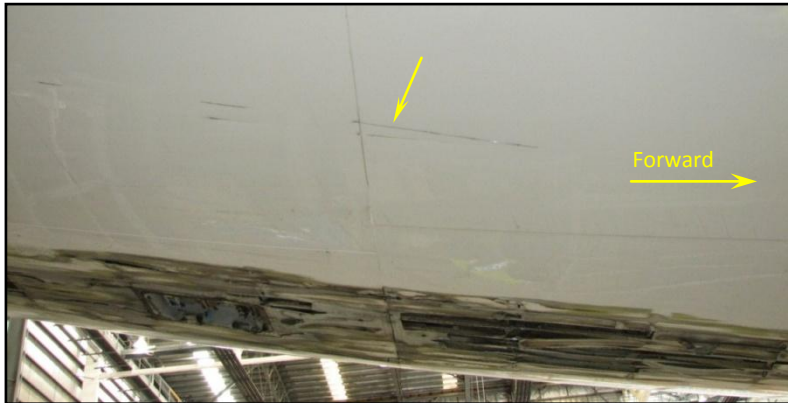

Figure 7: Contact mark on left main landing gear, inboard rear tyre



Temporary repairs were carried out in Melbourne by the aircraft manufacturer and the aircraft was flown to France for further engineering work to be carried out by the manufacturer.

Other damage

An inspection of the runway and overrun areas identified multiple contact marks (Figure 8). The tail of the aircraft made contact with the runway at three locations, each starting at the positions indicated by ① ② and ③ in Figure 8. After leaving the stopway, two contact marks were identified in the grassed area, indicated by ④ and ⑤ in Figure 8. Figure 9 shows typical ground contact marks. The aircraft also made contact with ground infrastructure; a runway 34 sequenced lead-in strobe light (Figure 10), and the runway 16 localiser monitor antenna (Figure 11). The damage to the runway 16 localiser antenna (Figure 12) was consistent with the contact mark on the left main landing gear inboard-rear tyre. The resulting damage to the antennas disabled the localiser function.

Figure 8: Ground contact marks



Figure 9: Typical contact marks on runway, stopway and grassed areas



Figure 10: Sequenced lead-in strobe light



Figure 11: Localiser monitor antenna

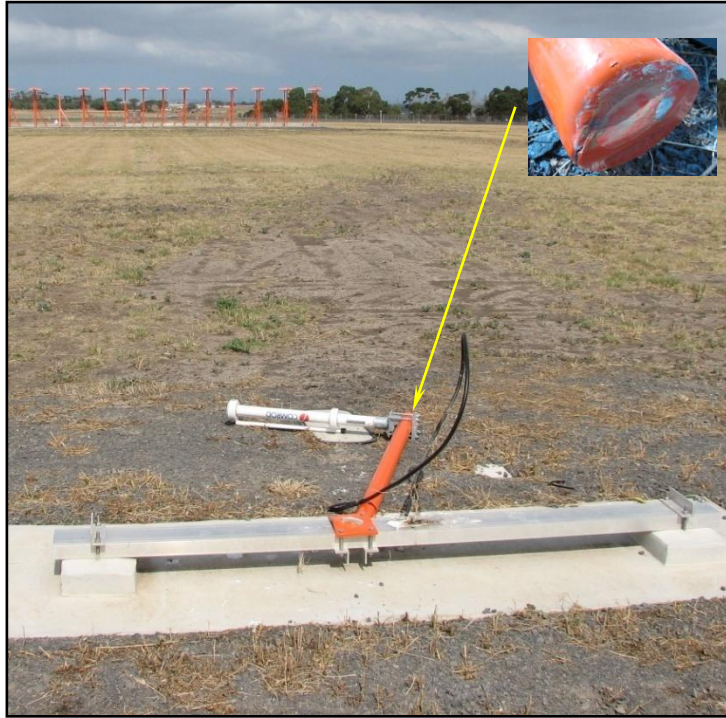

Figure 12: Localiser antenna array



Personnel information

Captain

Type of licence	Airline transport pilot (aeroplane) licence
Total flying hours	8,195 hours
Total flying hours on A340-500	1,372 hours
Total flying last 90 days	218.1 hours (27 flights)
Total flying last 90 days on A340-500	104 hours (11 flights)
Total flying last 30 days	98.9 hours (11 flights)
Total flying last 30 days on A340-500	69.3 hours (7 flights)
Total flying last 28 days	85.2 hours (10 flights)
Total flying last 28 days on A340-500	55.6 hours (6 flights)
Total flying last 7 days	14.5 hours (2 flights)
Total flying last 7 days on A340-500	14.5 hours (2 flights)
Last proficiency check	7 October 2008
Medical certificate	Class 1 – valid to 15 October 2009 nil restrictions

First officer

Type of licence	Airline transport pilot (aeroplane) licence
Total flying hours	8,316 hours
Total flying hours on A340-500	425 hours
Total flying last 90 days	199.2 hours (31 flights)
Total flying last 90 days on A340-500	124.2 hours (13 flights)
Total flying last 30 days	89.7 hours (10 flights)
Total flying last 30 days on A340-500	82.9 hours (8 flights)
Total flying last 28 days	76.2 hours (9 flights)
Total flying last 28 days on A340-500	69.3 hours (7 flights)
Total flying last 7 days	21.3 hours (4 flights)
Total flying last 7 days on A340-500	14.5 hours (2 flights)
Last proficiency check	5 February 2009
Medical certificate	Class 1 – valid to 6 August 2009 nil restrictions

Augmenting flight crew

For long-range sectors, where the flight time extended beyond the permissible flight duty time for the primary flight crew, a second ‘augmenting’ crew was carried on board the aircraft to allow the primary crew to rest during the cruise segment of the flight. The augmenting crew were positioned in the cockpit observer seats for takeoff (Figure 16).

The augmenting crew members' responsibilities were listed in the operator's *Flight Operations Manual* as:

Augmented Crew Responsibilities

- Their responsibilities include (but are not limited to):
 - Participate in Pre (&Post) flight Briefings and Flight Planning.
- Whilst onboard the aircraft, and not resting:
 - Participate in flight deck briefings and to actively monitor the flight path of the aircraft and actions of the PF [pilot flying] and PNF [pilot not flying].
 - Maintain a situational and operational awareness.
 - Bring to the attention of the operating crew any abnormalities or departure from SOPs and previously briefed intentions.
 - Duties delegated by the PIC [pilot in command].
 - Note: Use of the augmenting pilot to assist with flight preparation and other duties does not absolve any operating pilot of his SOP defined responsibilities. Care must be taken to ensure that no aspects of any operational responsibilities are overlooked.

Augmenting captain

Type of licence	Airline transport pilot (aeroplane) licence
Total flying hours	12,486.8 hours
Total flying hours on A340-500	694.1 hours
Total flying last 90 days	175.3 hours (46 flights)
Total flying last 90 days on A340-500	44.3 hours (6 flights)
Total flying last 30 days	80.9 hours (16 flights)
Total flying last 30 days on A340-500	44.3 hours (6 flights)
Total flying last 28 days	70.5 hours (13 flights)
Total flying last 28 days on A340-500	44.3 hours (4 flights)
Total flying last 7 days	22.3 hours (4 flights)
Total flying last 7 days on A340-500	22.3 hours (4 flights)
Last proficiency check	28 December 2008
Medical certificate	Class 1 – valid to 7 May 2009 nil restrictions

Augmenting first officer

Type of licence	Airline transport pilot (aeroplane) licence
Total flying hours	6,438 hours
Total flying hours on A340-500	543 hours
Total flying last 90 days	153.6 hours (34 flights)
Total flying last 90 days on A340-500	33.4 hours (5 flights)

Total flying last 30 days	60.4 hours (11 flights)
Total flying last 30 days on A340-500	22.3 hours (4 flights)
Total flying last 28 days	54.4 hours (10 flights)
Total flying last 28 days on A340-500	22.3 hours (4 flights)
Total flying last 7 days	22.3 hours (4 flights)
Total flying last 7 days on A340-500	22.3 hours (4 flights)
Last proficiency check	5 March 2009
Medical certificate	Class 1 – valid to 6 July 2009 nil restrictions

Flight crew trip history

The operator scheduled a return trip from Dubai (DXB) to Auckland (AKL), New Zealand, via Melbourne (MEL) under two flight numbers; EK406 from Dubai to Auckland, via Melbourne; and EK407 returning from Auckland to Dubai, via Melbourne. The flights departed each port on a daily basis. The trip consisted of a total of four sectors. The accident flight was the fourth sector of the trip.

The captain and first officer departed Dubai at 1013 Dubai time (0613 UTC) on 18 March 2009 as the primary crew of Flight EK406. The flight was 13 hours duration and arrived in Melbourne at 0613 on 19 March Melbourne time (1913 on 18 March UTC) (Figure 13). The crew was rostered off duty in Melbourne until recommencing duty for the return flight to Dubai on 20 March.

The augmenting flight crew (captain and first officer) departed Dubai at 1010 Dubai time (0610 UTC) on 16 March 2009 as the augmenting crew on Flight EK406. The flight was 13 hours and 13 minutes duration and arrived in Melbourne at 0623 on 17 March Melbourne time (1923 on 16 March UTC). The augmenting crew then became the operating crew of the next sector of flight EK406 to Auckland, departing Melbourne at 0810 on 18 March Melbourne time (2110 on 17 March UTC) and arriving in Auckland at 1339 Auckland time (0039 on 18 March UTC), a duration of 3 hours and 29 minutes.

The augmenting flight crew operated the return sector from Auckland to Melbourne on 19 March as the operating crew of Flight EK407. The flight departed Auckland at 1845 Auckland time (0545 UTC) and arrived in Melbourne at 2050 Melbourne time (0950 UTC), a duration of 4 hours and 5 minutes (Figure 13). The Melbourne-Auckland-Melbourne sectors were operated as 2-crew operations.

The flight crews were rostered off duty between their respective sectors as shown below (Figure 13).

Figure 13: Flight crew trip history

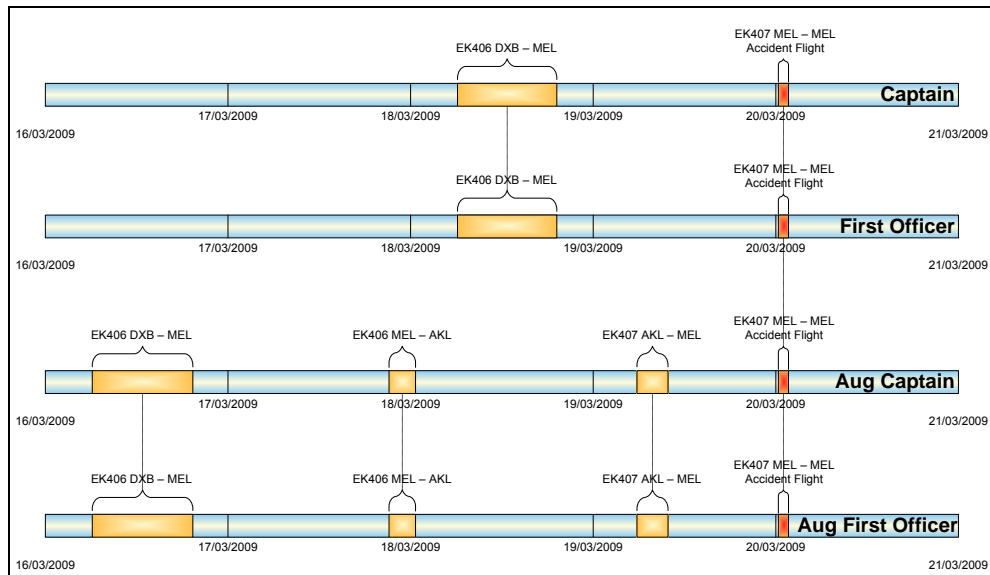

DXB = Dubai, United Arab Emirates MEL = Melbourne, Australia

AKL = Auckland, New Zealand

Note: Times and dates are relative to UTC. Melbourne was UTC +11 hours

Flight time limitations

The United Arab Emirates General Civil Aviation Authority (GCAA) had approved the flight and duty limitation program specified in the operator's *Flight Operations Manual*. That program specified a maximum limitation on flying time of 100 hours in a 28-day period. At the commencement of the accident flight, none of the flight crew members had exceeded the 100 hour flying time limitation.

Ultra Long Range (ULR)¹⁴ operations were required to adhere to the guidance published in the GCAA Civil Aviation Advisory Publication (CAAP) 14, *ULR Operations*. That guidance included the recommendation that operators have a Fatigue Risk Management System (FRMS) in place for ULR operations. The aircraft operator had a FRMS that was approved by the GCAA for ULR operations.

Application of flight crew fatigue models

The flight crew's work and sleep history was entered into the Fatigue Avoidance Scheduling Tool (FAST)¹⁵ that was originally developed for the US Air Force. The FAST software predicts effective performance using calculations developed from empirical research findings of studies into the effects that wakefulness and circadian rhythms have on cognitive performance. These calculations take into account both work and sleep patterns as well as the quality of sleep.

¹⁴ According to GCAA CAAP 14, *ULR Operations* dated 1 September 2003, an ultra long range operation was 'An operation involving any sector between a specific city pair (Point A - Point B - Point A) where the scheduled flight time could exceed 16 hours at any time during a calendar year taking into account the mean and seasonal wind changes'.

¹⁵ Eddy, D.R; Hursh, S.R. (2001). *Fatigue Avoidance Scheduling Tool (FAST)*. Brooks AFB, TX: AFRL/HEOA; 2001; Report No: AFRL-HEBR-TR-2001-0140.

The output from FAST focuses on establishing an individual's 'task effectiveness score'. Both crew members had a score that was near the top of the effectiveness range.

The operator supplied the results from another commercially available fatigue modelling tool that was used as part of their FRMS. That model used work hours and sleep/wake data to determine an 'alertness prediction', and was developed from data collected in laboratory studies and on long-haul flights. Those results correlated with the FAST assessment.

The examination of flight and duty times and fatigue is continuing.

Aircraft information

General

The aircraft was a four-engine (turbofan), low-wing aeroplane that was configured to seat 258 passengers in a three class cabin (Figure 14).

Figure 14: A340-541

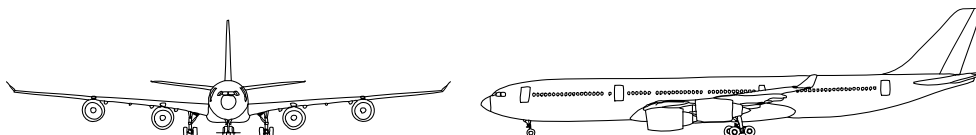

Source: A340-500 FCOM Vol 1

Manufacturer	Airbus
Model	A340-541
Serial number	608
Registration	A6-ERG
Year of manufacture	2004
Certificate of airworthiness	
Issuing authority	General Civil Aviation Authority United Arab Emirates
Issue date	30 November 2004
Period of validity	30 November 2008 to 29 November 2009
Certificate of registration	
Issuing authority	General Civil Aviation Authority United Arab Emirates
Issue date	30 November 2004
Total airframe hours/cycles	22,526/2,598
Last 'A' maintenance check	11 March 2009
Next scheduled maintenance due	29 March 2009
Maximum certified take-off weight	372,000 kg
Maximum certified landing weight	243,000 kg
Maximum certified zero fuel weight	230,000 kg

Engines

The aircraft was equipped with four Rolls Royce (RR) Trent 553-61 high-bypass turbofan engines. Each engine was certificated at 270 kN (60,000 lb) thrust but derated¹⁶ to 240 kN (53,000 lb) thrust for operation on the A340-500 series aircraft.

High lift devices

The aircraft was equipped with leading edge slats (slats) and trailing edge flaps (flaps) to increase the lift that was able to be produced by the wings. The aircraft also drooped the ailerons (lowered their trailing edge) when the flaps were lowered to further increase the lift while maintaining lateral control (Figure 15).

Figure 15: High lift devices

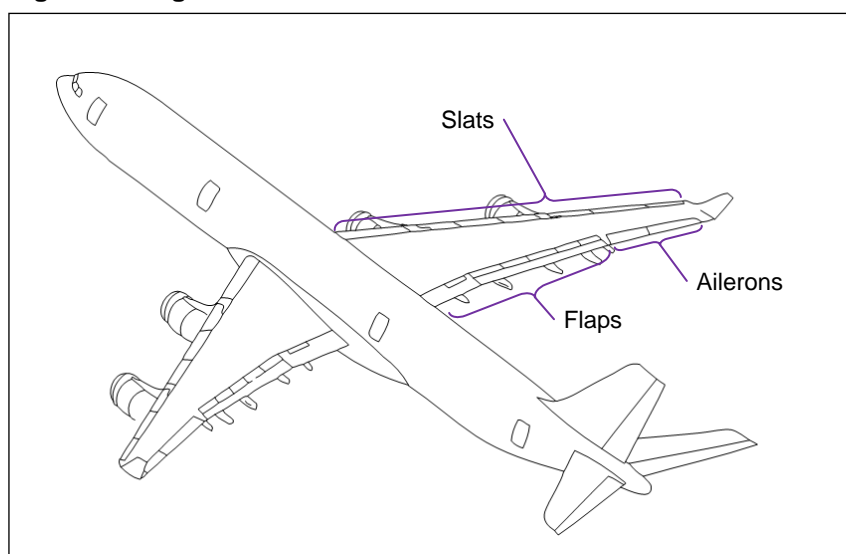

Source: A340-500 FCOM Vol 1

The various combinations of flap, slat and aileron droop that could be selected are shown in Table 3.

Table 3: Flap settings

Lever Position	Slats	Flaps	Ailerons	Indication on ECAM	Flight Phase		
0	0	0	0				Cruise
1	21	0	0	1	Takeoff		Hold
		17	10	1 + F			
2	24	17	10	2	Takeoff		Approach
	24	22	10	2			
3	24	29	10	3	Landing		
FULL	24	34	10	FULL			

Source: A340-500 FCOM Vol 1

¹⁶ De-rating an engine restricts the thrust output to a level below the potential maximum for the engine design.

Design operating crew

The aircraft was designed and certificated to be operated by two pilots (captain and first officer). The design allowed for an additional two persons to be seated in the cockpit. On the accident flight, the additional seats were occupied by the augmenting flight crew as shown in Figure 16.

Figure 16: Cockpit arrangement

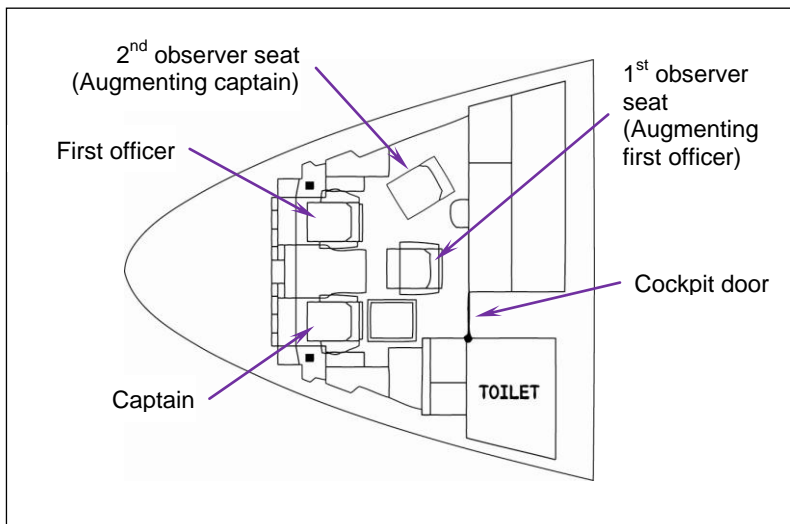

Source: A340-500 FCOM Vol 1

Flight management and guidance system

Introduction

The aircraft was equipped with a flight management and guidance system (FMGS) that included two flight management, guidance and envelope computers, and three multi-purpose control and display units (MCDU). The FMGS computers contained performance data that was used by the autothrottle and autopilot systems to guide the aircraft along a pre-planned route, altitude and speed profile.

The flight crew could interface with the FMGS either through the MCDUs located on the pedestal between the two pilots, or through the flight control unit located in the centre of the glare shield, above the forward instrument panels (Figure 17).

Figure 17: Flight management and guidance system

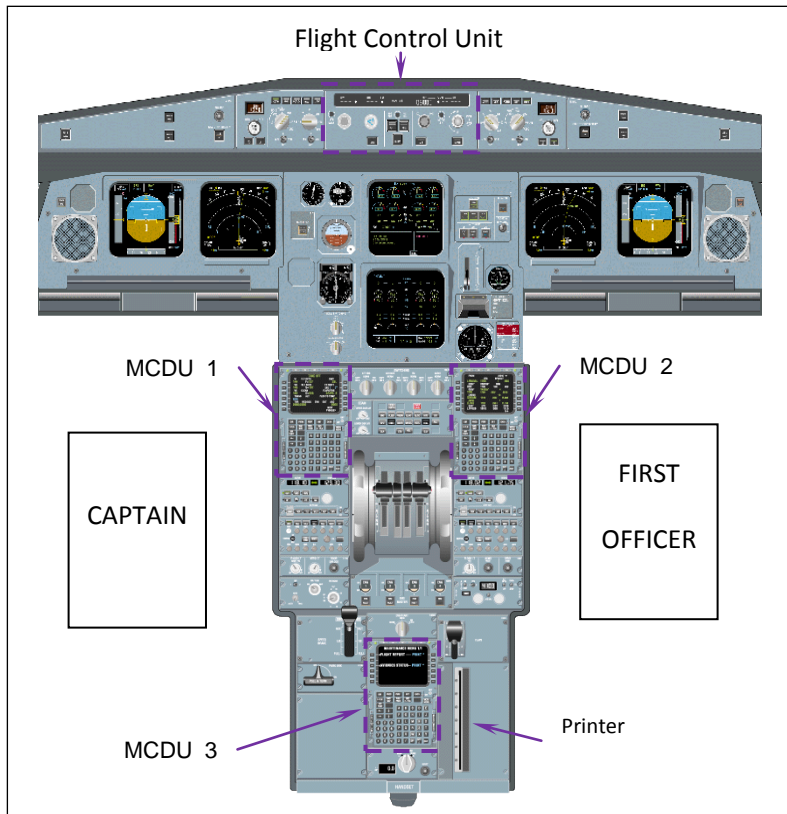

Source: A340-500 FCOM Vol 1

Note: example shown for illustration only and does not contain data from the accident flight.

MCDU INIT [initialisation] B page

The MCDU initialisation B page (MCDU INIT B page) was used by the flight crew in their pre-flight preparation to enter the aircraft's zero fuel and block fuel weights (ZFW and BLOCK FUEL) and zero fuel weight centre of gravity position (ZFWCG) into the FMGS (Figure 18). That data was obtained from the load sheet and entry was accomplished prior to engine start. The MCDU INIT B page then displayed the computed take-off and landing weights.

Figure 18: MCDU INIT B page

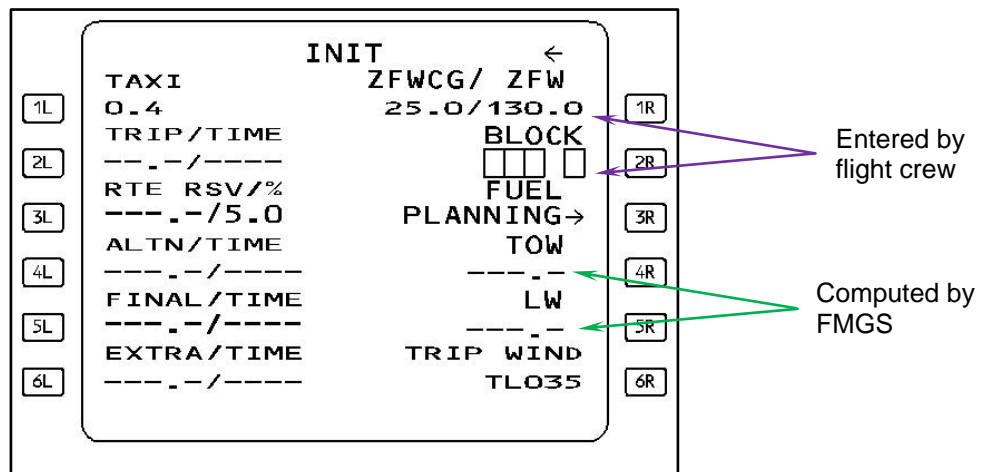

Source: A340-500 FCOM Vol 4

Note: example shown for illustration only and does not contain data from the accident flight.

MCDU PERF [performance] TAKE OFF page

The MCDU performance take-off page (MCDU PERF TAKE OFF page) was used by the flight crew to enter and modify the calculated take-off parameters, including; the take-off reference speeds (V_1 , V_R and V_2); the transition, thrust reduction and acceleration altitudes; the flap setting; the horizontal stabiliser trim setting; the FLEX temperature; and the engine out acceleration altitude (Figure 19).

Figure 19: MCDU PERF TAKE OFF page

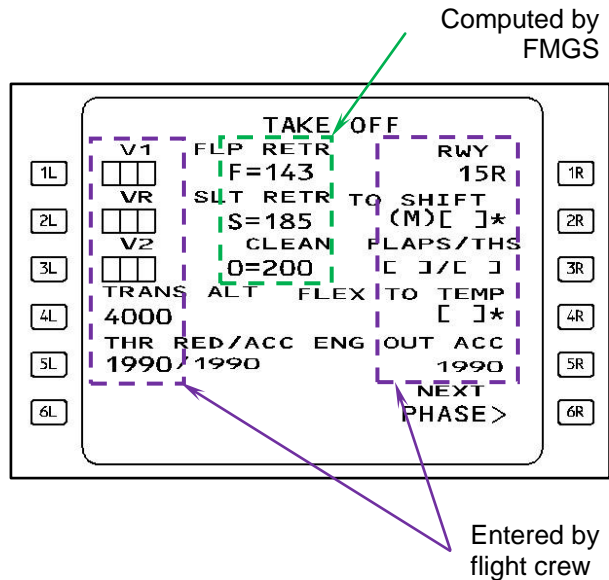

Source: A340-500 FCOM Vol 4

Note: example shown for illustration only and does not contain data from the accident flight.

Other displays of aircraft weights and take-off speeds

The aircraft's current gross weight (GW)¹⁷ and gross weight centre of gravity position (GWCG) were also displayed on the electronic centralised aircraft monitor (ECAM) system display (Figure 20).

Figure 20: ECAM system display - Gross weight and centre of gravity

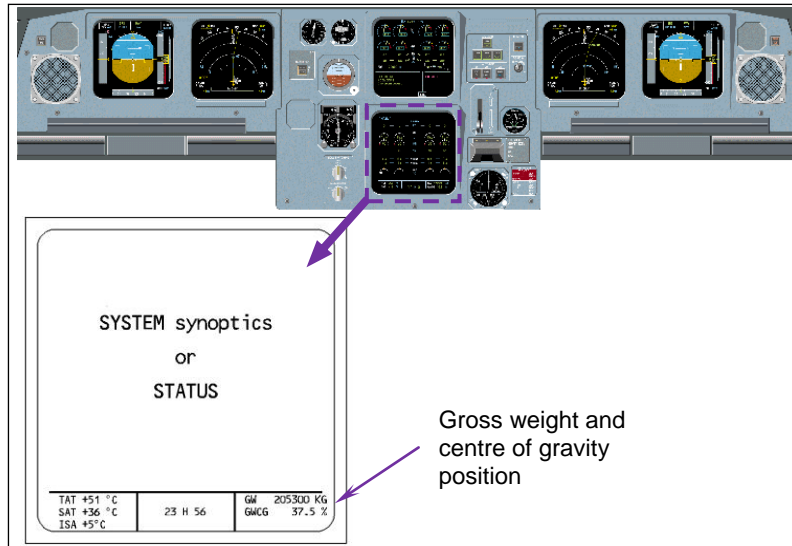

Source: A340-500 FCOM Vol 1

Note: example shown for illustration only and does not contain data from the accident flight.

The take-off reference speeds were displayed on the primary flight display speed scale. V_1 was denoted as a blue numeral '1', V_R as a blue circle and V_2 as the blue target speed triangle (Figure 21).

Figure 21: Presentation of take-off reference speeds

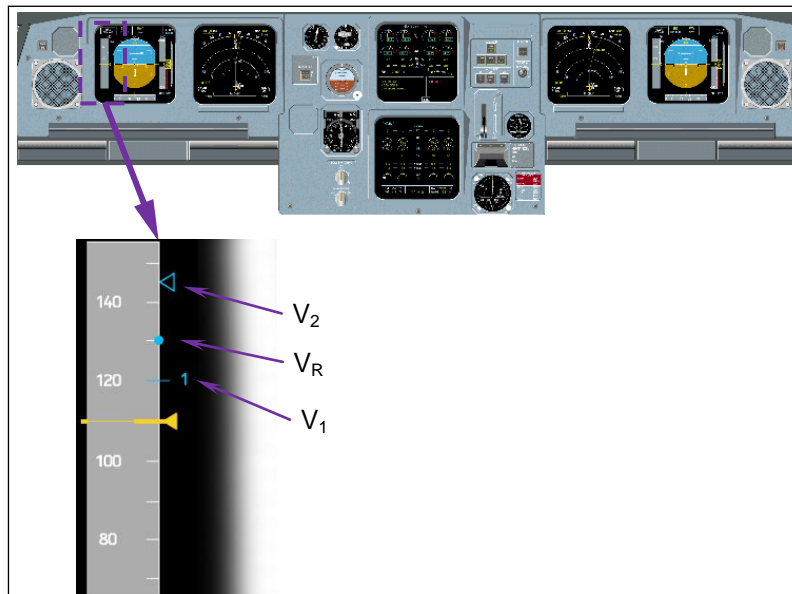

Source: A340-500 FCOM Vol 1

Note: example shown for illustration only and does not contain data from the accident flight.

¹⁷ The gross weight is the current weight of the aircraft. It is calculated from the zero fuel weight plus the current fuel weight.

Aircraft tailstrike limit

Pitch attitude limit

In June 2004, the aircraft manufacturer issued the Flight Crew Operating Manual (FCOM) Bulletin 'Avoiding Tailstrikes'. That FCOM Bulletin listed the pitch attitude limit on the ground for the A340-500 series aircraft as:

13.5° - with main oleos¹⁸ fully extended

9.5° - with main oleos fully compressed

Figure 22: Pitch attitude limits

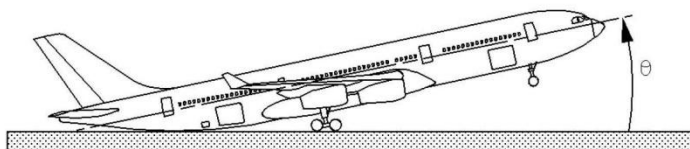

Source: Airbus FCOM Bulletin No 807/1

Tailstrike pitch limit indicator

The pitch limit indicator on the primary flight display (PFD) indicated the maximum pitch attitude ('V' symbol) at which the aircraft could be flown so as to avoid the risk of a tailstrike during takeoff and landing (Figure 23).

Figure 23: Tailstrike pitch limit indicator

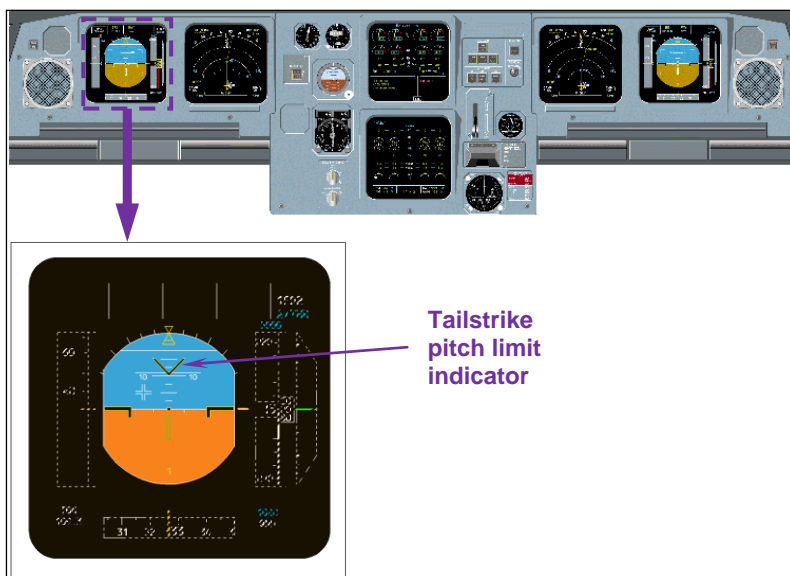

Source: A340-500 FCOM Vol 1

Note: example shown for illustration only and does not contain data from the accident flight.

During takeoff, the indicator progressed from the pitch limit value with main landing gear compressed, to the pitch limit value with main landing gear extended. The

¹⁸ An oleo is a telescopic shock absorber in an aircraft's landing gear that is used to absorb the vertical energy during landing.

indication was removed from the PFD 3 seconds after lift-off, when there was no longer the risk of a tailstrike.

Electronic centralised aircraft monitor [ECAM] tailstrike indication

The aircraft was equipped with a tailstrike detection system which was mounted on the underside of the rear fuselage. When the sensor detected a tailstrike, a warning (amber TAIL STRIKE) would be generated on the ECAM engine/warning display. The warning was inhibited from being displayed until the aircraft had left the ground, to prevent distracting the crews during the critical take-off phase.

Figure 24: Tailstrike ECAM warning

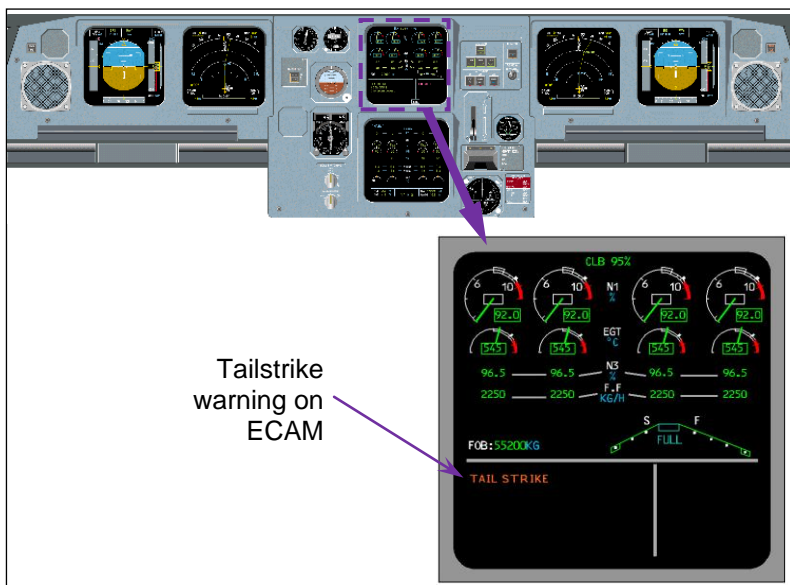

Source: A340-500 FCOM Vol 1

Note: example shown for illustration only and does not contain data from the accident flight.

Weight and Balance

The following information was taken from the ACARS load sheet that was transmitted to the flight crew at 1053:31 UTC:

Dry operating weight ¹⁹	183,235 kg
Zero fuel weight ²⁰	226,549 kg
Take-off fuel	135,300 kg
Take-off weight (A)	361,849 kg
Estimated fuel burn-off	125,300 kg
Estimated landing weight (B)	236,549 kg

¹⁹ The dry operating weight is the total weight of an aircraft for a specific type of operation, excluding the usable fuel and traffic load (cargo, passengers and bags).

²⁰ The zero fuel weight is the total weight of an aircraft for a specific type of operation including the traffic load (cargo, passengers and bags), but excluding the usable fuel.

- (A) The flight crew reported that the performance calculations were normally based on the load sheet with the conservative addition of one tonne to allow for late changes to the aircraft's weight.
- (B) Estimated landing weight for Dubai. The approximate landing weight at Melbourne following the accident was 280,000 kg.

Take-off centre of gravity was 27.1% of the mean aerodynamic chord²¹, and was within the approved limits for the aircraft.

Meteorological information

Aerodrome forecasts

The Bureau of Meteorology (BoM) issued a terminal aerodrome forecast (TAF) for Melbourne Airport at 1535 on 20 March 2009 with a local time validity period from 1700 on 20 March to 2300 on 21 March. The forecast was issued 6 hours 30 minutes prior to the aircraft's scheduled departure time from Melbourne, and the validity encompassed the aircraft's planned takeoff and climb in the Melbourne area. The forecast wind was 180° true (T) at 12 kts, the weather conditions being CAVOK²², outside air temperature (OAT) 19° C and QNH²³ 1014 hPa.

Actual weather information

The Melbourne routine aerodrome weather report (METAR) that was issued at 2200 indicated that the wind was from 240° T at 4 kts, the OAT was 16° C, conditions were CAVOK with a QNH of 1014 hPa. The trend type forecast (TTF) appended to that METAR indicated that no significant changes to the existing conditions were expected during the following 3 hours, which encompassed the aircraft's planned departure time.

The Melbourne METAR that was issued at 2230 (2 minutes before the accident) indicated that the wind was from 260° T at 3 kts, an OAT of 17° C, and CAVOK conditions with a QNH of 1015 hPa. The 1-minute data generated by the Melbourne Airport Automatic Weather Station at 2231:58 (the time of the accident) indicated that the wind was 304° T at 6 kts, with an ambient air temperature of 16° C and a QNH 1015 hPa.

The Melbourne Airport automatic terminal information service (ATIS) 'Uniform' was broadcast during the period prior to the aircraft's departure. The ATIS

²¹ Mean aerodynamic chord. The chord of an imaginary wing of constant section that has the same force vectors under all conditions as those of the actual wing. The centre of gravity location is normally referenced relative to the mean aerodynamic chord.

²² The abbreviation CAVOK [Ceiling and Visibility and weather OK] is used when the following conditions are forecast simultaneously: visibility, 10 kilometres or more; no cloud below 5,000 ft above the aerodrome level or the highest 25 NM (46 km) minimum sector altitude, whichever is the higher, and no cumulonimbus or towering cumulus cloud at any height; and no weather of significance to aviation.

²³ QNH is the barometric pressure setting that enables an altimeter to indicate altitude; that is, the height above mean sea level.

information included a wind of 250° magnetic (M) at 5 kts, with a maximum downwind on runway 16 of 2 kts, an OAT of 17° C, CAVOK and a QNH of 1015 hPa. The crew obtained a copy of 'Uniform' from the onboard ACARS at 2157, 21 minutes prior to departure.

Aids to navigation

At the time of the accident, the flight crew members were using visual references for the takeoff and were not relying on ground-based navigation aids.

Aerodrome information

Melbourne Airport is located about 20 km north-west of the Melbourne central business district at an elevation of 434 ft above mean sea level (AMSL). The airport had two runways: runway 16/34, aligned 160/340° M, and runway 09/27, aligned 083/263° M. Runway 16 was in use at the time of the accident.

Runway 16 was constructed of asphalt with concrete ends, and was 3,657 m long and 60 m wide. The touchdown elevation of runway 16 was 432 ft and the runway sloped down to 330 ft at the departure (southern) end. At the end of the runway, there was a stopway²⁴ extending for 60 m, and a clearway²⁵ that extended 120 m from the end of the runway.

The runway 16 localiser²⁶ antenna system was located at the southern end of runway 16 and consisted of a transmitter antenna array and a monitor antenna (Figure 8). The localiser monitor antenna (Figure 11) was located 200 m from the end of the runway. The monitor antenna was 0.7 m tall, and the top of the antenna was about 0.4 m below the height of the departure end of runway 16. The localiser antenna array (Figure 12) was located 328 m from the end of the runway. The array was 4 m tall, and the top of the array was about 0.1 m below the height of the departure end of runway 16. The localiser antennas were reported to have been designed as 'frangible' structures in accordance with the International Civil Aviation Organization (ICAO) Aerodrome Design Manual, Part 6.

Also located beyond the southern end of runway 16, were the runway 34 sequenced lead-in strobe lights (Figure 10), consisting of three strobe lights that were mounted on concrete pads. The strobes were located 177 m, 337 m, and 487 m from the end of runway 16. The tops of these strobe lights were about 1.5 m, 2.23 m, and 3.6 m respectively below the height of the departure end of runway 16. The strobe lights were reported to also have been designed as 'frangible' structures in accordance with the ICAO Aerodrome Design Manual, Part 6.

The ground surface surrounding the area at the end of runway 16 consisted of dry soil, with a sparse cover of dry grass.

²⁴ 'A defined rectangular area on the ground at the end of take-off run available prepared as a suitable area in which an aircraft could be stopped in the case of an abandoned take off.' (ICAO Annex 14 Volume 1, 5th edition, July 2009).

²⁵ 'A defined rectangular area on the ground or water under the control of the appropriate authority, selected or prepared as a suitable area over which an aeroplane may make a portion of its initial climb to a specified height.' (ICAO Annex 14 Volume 1, 5th edition, July 2009).

²⁶ The localiser is part of the instrument landing system and provides lateral tracking guidance.

Flight recorders

Overview

The aircraft was equipped with three flight recorders:

- a flight data recorder (FDR)
- a cockpit voice recorder (CVR)
- a digital ACMS (aircraft condition monitoring system) recorder (DAR)²⁷.

The FDR and CVR were mandatory fitment recorders for this aircraft, with the recorded flight data stored within crash-protected memory modules that were located near the tail of the aircraft. The FDR recorded aircraft parameters defined by regulatory requirements.

The DAR was utilised by the aircraft operator for flight data and aircraft system monitoring activities. The aircraft flight parameters that were recorded by the DAR included most of the FDR parameters, with additional parameters as configured by the operator. The information recorded on the DAR was not crash-protected, and was stored on a removable PC-card.

Recording system operation

FDR system

The FDR fitted to A6-ERG was a Honeywell Solid State Memory Flight Data Recorder (Part Number 980-4700-042) that stored about 1,200 aircraft parameters. The FDR was required to store the last 25 hours of recorded flight data, capturing at least from engine start to 5 minutes after engine shutdown for each flight.

CVR system

The CVR fitted to A6-ERG was a Honeywell Solid State Memory Cockpit Voice Recorder (Part Number 980-6022-001) and was required to retain the last 2 hours of audio information. The CVR was installed to record the cockpit audio environment, including: crew conversation, radio transmissions, aural alarms, control movements, switch activations, and engine and airflow noise.

DAR system

The DAR recorded flight data on a PC-card as part of the aircraft's flight data interface and management unit (FDIMU). The DAR retained several days of aircraft flight data.

²⁷ The DAR was the airline-configurable data from the flight data interface and management unit (FDIMU) output to a memory card.

Flight recorder retrieval

The examination and retrieval of the flight recorders was undertaken under Australian Transport Safety Bureau (ATSB) supervision on 21 March 2009. The FDR had separated from its mounting rack and was located in a small compartment directly to the rear of the mounting rack and adjacent to the tail lower skin (Figure 25).

Figure 25: Location of FDR as found with FDR mounting rack in view (arrowed)

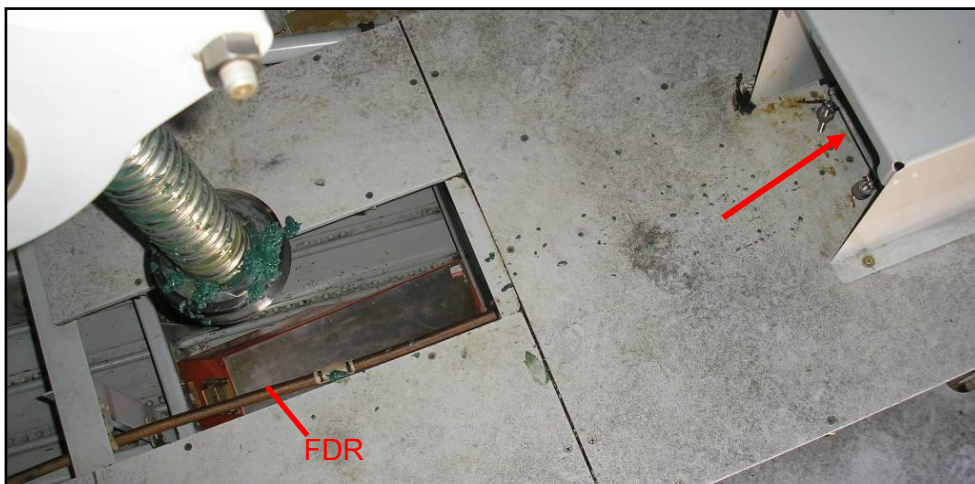

The FDR mounting rack displayed evidence of deformation with part of one securing nut found to have separated from the rack. The CVR and DAR PC-card were in their correct locations and undamaged.

Flight recorder download

FDR

The FDR was found to contain 27 hours of flight data, which comprised four previous flights and the initial part of the accident flight. The accident flight data commenced at 2156 (1056:00 UTC) but ended as the aircraft passed over the departure or southern end of runway 16 during the tailstrike.

CVR

The CVR contained 125 minutes of good quality audio data. The audio included the entire accident flight, having commenced while the flight crew were carrying out their pre-flight checks with the aircraft at the departure gate.

DAR

The DAR PC-card contained flight data from three previous flights and the entire accident flight. The DAR and FDR data were consistent with each other up to the point of FDR data stoppage. The DAR flight data was consequently used in the preparation of a sequence of events for the accident flight. A graphical representation of the DAR data during the takeoff is presented in Appendix A.

Key event snapshots of the take-off roll are shown in Appendix B.

Sequence of events

Table 4 provides a sequence of events prepared from data from the flight recorders. Times are based on UTC. Local time is UTC plus 11 hours.

Table 4: A6-ERG accident flight sequence of events

Time (UTC) (hh:mm:ss)	Event Description	Distance from RWY 16 end (m) ²⁸ (Note runway length = 3,657m)
10:53:14	Start of CVR recording	N/A
10:56:00	Start of FDR recording	N/A
11:18:28	Push back from gate	N/A
11:19:31	Engines started	N/A
11:21:20	Start of DAR recording	N/A
11:30:48	Aircraft lined up on runway 16	3,540
11:30:49	Brakes released	3,537
11:30:51	Ground speed begins to increase	3,536
11:30:55	Thrust levers set to FLX/MCT thrust lever detent, engine pressure ratio (EPR) = 1.14	3,529
11:31:31	Aircraft computed airspeed (CAS) = 100 kts. Groundspeed (GS) = 104 kts	2,474
11:31:52	Aircraft CAS 143 kts corresponding to V ₁ GS = 149 kts	1,118
11:31:54	First officer commences nose-up pitch command on sidestick. CAS = 147 kts. GS = 152 kts	964
11:31:55	Aircraft started to rotate. CAS 152 kts, GS = 158 kts. FO pitch command = -16°	886
11:31:57	Nose gear uncompressed	727
11:32:03	<i>Initial tail contact with runway, pitch angle = 9.8°, right and left main gear still compressed. CAS = 156 kts GS 167= kts</i> Captain commanded TOGA	229
11:32:05	Thrust levers moved to the TOGA detent, aircraft passes end of runway 16. TRA ²⁹ = 85°. CAS = 157 kts, GS = 169 kts, FDR recording ends	0
11:32:07	Pitch increased to 13.7°. Right and left main gear uncompressed. CAS = 161 kts, GS = 172 kts.	-115
11:32:09	Positive rate of climb established	-292

²⁸ Calculated from the aircraft's groundspeed as recorded on the DAR.

²⁹ Thrust resolver angle, which is a measure of the thrust lever position set by the flight crew.

Time (UTC) (hh:mm:ss)	Event Description	Distance from RWY 16 end (m)²⁸ (Note runway length = 3,657m)
11:32:46	Landing gear retracted	N/A
11:35:45	Aircraft reached 5,000 feet	N/A
11:40:18	Aircraft reached 7,000 feet	N/A
11:46:19	PAN call to ATC	N/A
11:49:35	Fuel dump commenced	N/A
12:25:35	Fuel dump completed	N/A
12:26:11	Descent clearance given by ATC	N/A
12:27:47	First officer requested an immediate approach due to reports of smoke in the aircraft cabin	N/A
12:36:29	Touchdown at Melbourne Airport on runway 34	N/A

Other information

Reduced thrust takeoffs

The performance of an aircraft is affected by various factors, including the ambient air conditions (outside air temperature and pressure), flap configuration, the aircraft's weight and the thrust produced by the engines. To ensure the safety of operations, aircraft are certified to a minimum performance standard during takeoff. However, to allow for operations from a variety of airports, and to meet performance requirements under a variety of ambient conditions, many aircraft are capable of exceeding the minimum take-off performance standards. In such cases, carrying out every takeoff at maximum thrust would place unnecessary stresses on the engines, decreasing the life of the engines and, over time, potentially increasing the risk of an engine failure.

When aircraft are operated from an airport at a weight where the available performance exceeds the minimum performance standard with maximum thrust applied, the engine thrust applied to the takeoff can be reduced while still satisfying the performance standards. A safety margin is normally included in the calculations to ensure that the take-off performance is in excess of the minimum requirements. On Airbus aircraft, a reduced thrust takeoff is referred to as a FLEX takeoff.

The reduced thrust calculation determines a set of performance figures for the aircraft, including the take-off reference speeds and a calculated temperature that is referred to as the 'assumed temperature' (or FLEX temperature for Airbus aircraft). This assumed or FLEX temperature is the temperature at which the required take-off performance would be achieved for the aircraft weight and at the maximum engine thrust available at that calculated temperature. On the Airbus A340-541, the FLEX temperature is entered into the FMGS via the MCDU PERF TAKE OFF page (Figure 19, right column). The FMGS provides the FLEX temperature to the full authority digital engine control system (FADEC) to determine and control the

engine thrust setting when the throttles are advanced to the FLX/MCT³⁰ position for takeoff.

The thrust from a turbine engine is determined by, amongst other things, the density of the ambient air which is, in turn affected by the air temperature and pressure. The higher the air temperature, the lower the thrust produced. Thus, a higher FLEX temperature results in a lower thrust setting. The maximum thrust reduction permitted at the time of the accident was 40%, which equated to a maximum FLEX temperature of 75° C. When operating at a reduced thrust setting using a FLEX temperature, the flight crew could use the rated maximum take-off (TOGA) thrust at any time during the takeoff to maximise performance.

Airbus Less Paper Cockpit electronic flight bag system

Introduction

At the time of the accident, the flight crew was using the Airbus Less Paper Cockpit (LPC) electronic flight bag system to calculate relevant take-off and landing performance data. The LPC system was computer-based, and replaced the paper-based aircraft performance reference material by using a software application to automate take-off and landing performance calculations. The results of the take-off performance calculation were then manually entered into the FMGS by the flight crew.

The LPC system used a Microsoft Windows XP-based Airbus software application, containing performance data derived from the computerised A340-541 *Flight Crew Operating Manual (FCOM)*. The LPC software application was hosted on a laptop computer. The aircraft carried two laptops containing the LPC system. One was used during operation; the second was used as a backup in case of the failure of the first laptop.

Electronic flight bag hardware classes and software types

The US Federal Aviation Administration and the European Joint Aviation Authorities³¹ had issued guidance material in regard to the use of electronic flight bags (EFB).³² This guidance material divided EFBs into three hardware classes and three software types.

The LPC system was categorised as a Class 1 EFB, as it was based on a standard commercial laptop computer that was used as loose equipment in the flight deck and stowed during critical phases of flight. The laptop did not connect to the aircraft power supply or have data connectivity to other aircraft systems. The system was

³⁰ FLEX/Maximum Continuous Thrust.

³¹ The Joint Aviation Authorities (JAA) was an associated agency of the European Civil Aviation Conference (ECAC), which represented the civil aviation regulatory authorities of a number of European States. The JAA was disbanded on 30 June 2009 following a decision by the ECAC, and replaced by the European Aviation Safety Agency (EASA).

³² Refer to US Federal Aviation Administration Advisory Circular AC-120-76A, *Guidelines for the Certification, Airworthiness, and Operational Approval of Electronic Flight Bag Computing Devices*, 2003 and JAA Administrative and Guidance Material, Temporary Guidance Leaflet No. 36 (JAR-OPS), *Approval of Electronic Flight Bags (EFBs)*, 2004.

considered to be a portable electronic device and it did not require airworthiness approval.

The software within the LPC system was categorised as a Type B hosted application, as it was a dynamic, interactive performance application that was capable of manipulating data inserted by the flight crew.

Obtaining take-off performance data from the LPC

In order to determine aircraft take-off performance, the user selected the LPC take-off performance module and then selected the desired runway from the database ① (Figure 26). The user then entered the wind speed and direction ②, outside air temperature ③, altimeter setting (QNH) ④, proposed gross take-off weight ⑤, flap configuration ⑥³³, air conditioning status ⑦ anti-ice selection ⑧, runway surface condition ⑨, and aircraft centre of gravity position ⑩ into the LPC.

Figure 26: LPC takeoff performance screen

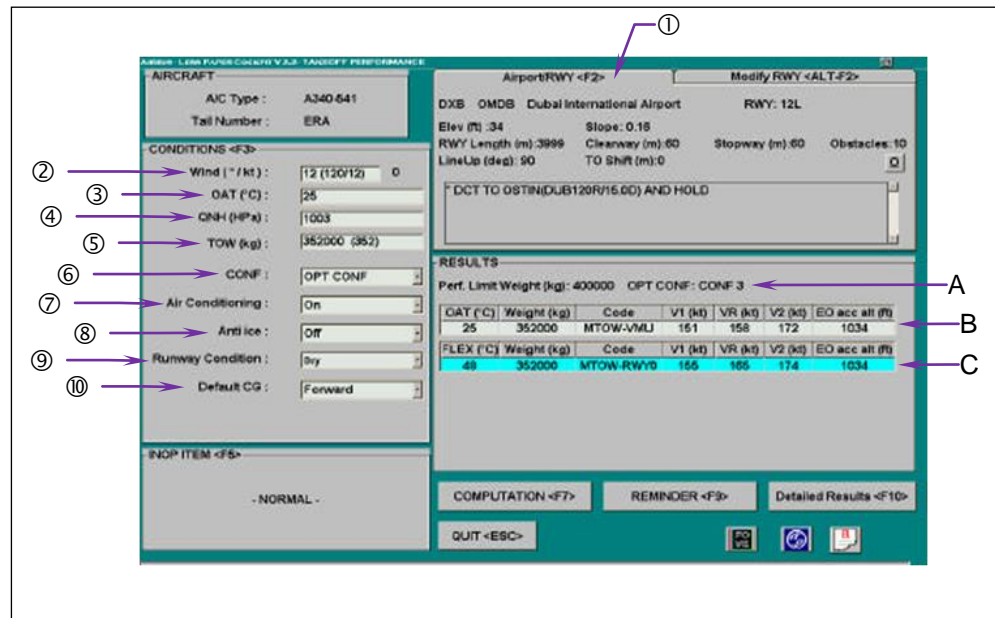

Source: A340-500 FCOM Vol 2

Note: example shown for illustration only and does not contain data from the accident flight.

The user then selected the COMPUTATION button and the LPC displayed the following output data:

- the performance-limited take-off weight and optimum flap configuration for the selected runway and entered conditions (A)
- the take-off speeds and the engine-out acceleration altitude for proposed gross take-off weight using full take-off power at the actual outside air temperature (B)

³³ The OPT CONF, or optimum configuration was normally used. This setting allowed the computation to determine the optimum aircraft configuration for takeoff. The optimum configuration was that which gave the lowest take-off speeds.

- the take-off speeds and the engine-out acceleration altitude for proposed gross take-off weight using less than full take-off power based on a computed FLEX take-off power temperature value (C).

The user then selected the REMINDER button, and the LPC displayed data in a format that emulated the FMGS MCDU take-off performance page (Figure 27). This data equated to the FLEX take-off power temperature data (C) displayed on the previous screen.

Figure 27: LPC takeoff performance screen with MCDU format



Source: A340-500 FCOM Vol 2

Note: example shown for illustration only and does not contain data from the accident flight.

Similar take-off performance-related occurrences

The investigation has so far identified 17 take-off performance-related events that have occurred world-wide between 1982 and 2009. Those events were found to have occurred across a range of aircraft types, operators, and types of operation.

As a result, the ATSB has commenced a safety research project (AR-2009-052) to examine these and other take-off performance-related accidents and incidents. When complete, the results of that research project will be published on the ATSB website at www.atsb.gov.au

In May 2008, following two tailstrike accidents that resulted from the use of erroneous weights in the respective performance calculations, the French Bureau d'Enquêtes et d'Analyses pour la sécurité de l'aviation civile (BEA)³⁴ issued a safety study report titled *Use of Erroneous Parameters at Takeoff*. A copy of that report is available for download from the BEA website at <http://www.bea.aero/en/index.php>.

³⁴ The BEA is the French agency with responsibility for technical investigations into civil aviation accidents or incidents under its jurisdiction.

ONGOING INVESTIGATION ACTIVITIES

The investigation is continuing and will include ongoing examination of:

- computer-based flight performance planning, including the effectiveness of the human interface with the supporting tools
- human performance and organisational risk controls, including:
 - a review of similar accidents and incidents
 - the implementation of, and training in standard operating procedures
 - the systems and processes relating to performance calculations
 - the existence and influence of distraction and interruption
 - those affecting flight and duty times and fatigue.
- reduced thrust takeoffs, and the use of erroneous take-off performance data, including:
 - the risks associated with reduced thrust takeoffs, and the management of those risks
 - crew ability to reconcile aircraft performance with their aircraft's take-off performance, and the associated decision making of the flight crew
 - preventative methods, especially technological advancements.

SAFETY ACTION

Following the accident, the aircraft operator and manufacturer initiated a number of safety actions to prevent recurrence of similar future accidents. That safety action is outlined in this interim factual report in order for other operators and manufacturers to consider the relevance of those actions to their operations.

Aircraft operator

On 17 April 2009, the aircraft operator informed the Australian Transport Safety Bureau (ATSB) that, based on their internal investigation into this accident, the following areas of their operation were under review:

- Human factors – including the current pre-departure, runway performance calculation and cross-check procedures, in order to determine whether the enhancement of those procedures was feasible and desirable, with particular regard to error tolerance and human factors issues.
- Training – including the operator’s initial and recurrent training in relation to mixed fleet flying and human factors.
- Fleet technical and procedures – including the introduction of a performance calculation and verification system that would protect against single data source entry error, by allowing at least two independent calculations.
- Hardware and software technology – including liaising with technology providers in reference to the availability of systems for detecting abnormal take-off performance.

On 20 October 2009, the aircraft operator advised the ATSB that a number of the working groups that were established following the accident were examining all of the operator’s aircraft types across its fleet. The working groups identified areas where safety could be enhanced and, as a result, a number of safety enhancements were implemented. These included the:

- conduct of briefings for all company flight crew to raise their awareness of the safety aspects of this accident;
- provision on the flight deck of a second laptop-based electronic flight bag (where not already provided) and a change in the operating procedures to require each laptop to be used by a different flight crew member to independently calculate the take-off performance;
- liaison with the aircraft manufacturer to improve the laptop-based electronic flight bag user interface;
- inclusion of dedicated modules on distraction management in the operator’s crew resource management training syllabi;
- education of support staff on flight crew distraction and adjustments to pre-departure procedures to reduce the opportunities for such distraction;
- clarification of the role of the augmenting flight crew, in relation to the operating crew and the pre-departure process;

- improvement of operational flight plans to include specific entry locations for all pertinent information; and
- initiation of discussions with aircraft manufacturers and technology designers to urgently provide improved systems to protect against potential errors during the pre-departure phase.

The working groups also identified a number of other areas that required further consideration and/or the involvement of aircraft and system manufacturers. They included the:

- improvement of the presentation, functionality and ergonomics of the laptop-based electronic flight bag to further reduce the opportunity for data input errors;
- development of a process to increase crews' situational awareness during the pre-departure phase, to indicate reasonable values for the aircraft take-off reference speeds and thrust settings;
- improvement of its aircraft's flight management and guidance systems to reduce the possibility of data input errors, such as unreasonable take-off reference speeds;
- provision of a system for a fully-independent performance data calculation; and
- development of a system to alert flight crews to abnormal take-off performance at an early stage during their take-off runs.

Aircraft manufacturer

In July 2009, Airbus announced in their *Safety First* magazine that they were developing a software package, termed the 'Take-off Securing' function that automatically checks the data being entered into the flight management and guidance system for consistency. A copy of that article is included in Appendix C.

On 17 November 2009, Airbus informed the ATSB that a new Less Paper Cockpit (LPC) was available that included changes to the flight crew-LPC interface, and that they are continuing to liaise with the aircraft operator.

Australian Transport Safety Bureau

On 20 August 2009, the ATSB commenced a safety research project (AR-2009-052) to examine the extent of take-off performance-related accidents and incidents and to identify any associated safety issues.

The ATSB has drawn the information in this report to the attention of relevant Australian operators, highlighting the issues associated with calculating and checking take-off performance information.

APPENDIX A: GRAPHICAL REPRESENTATION OF FLIGHT DATA

Figure A1: Selected DAR parameters for entire take-off roll

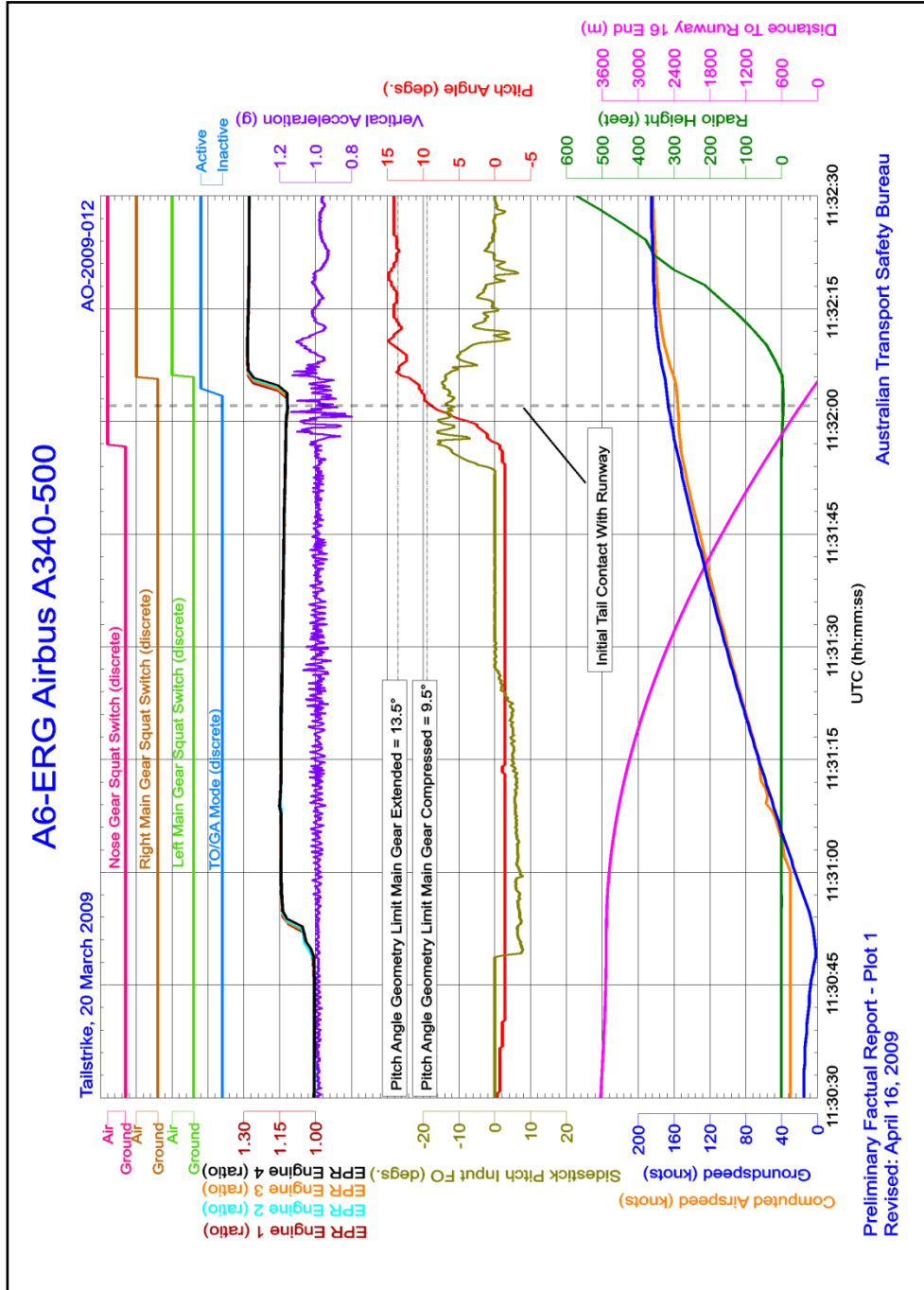
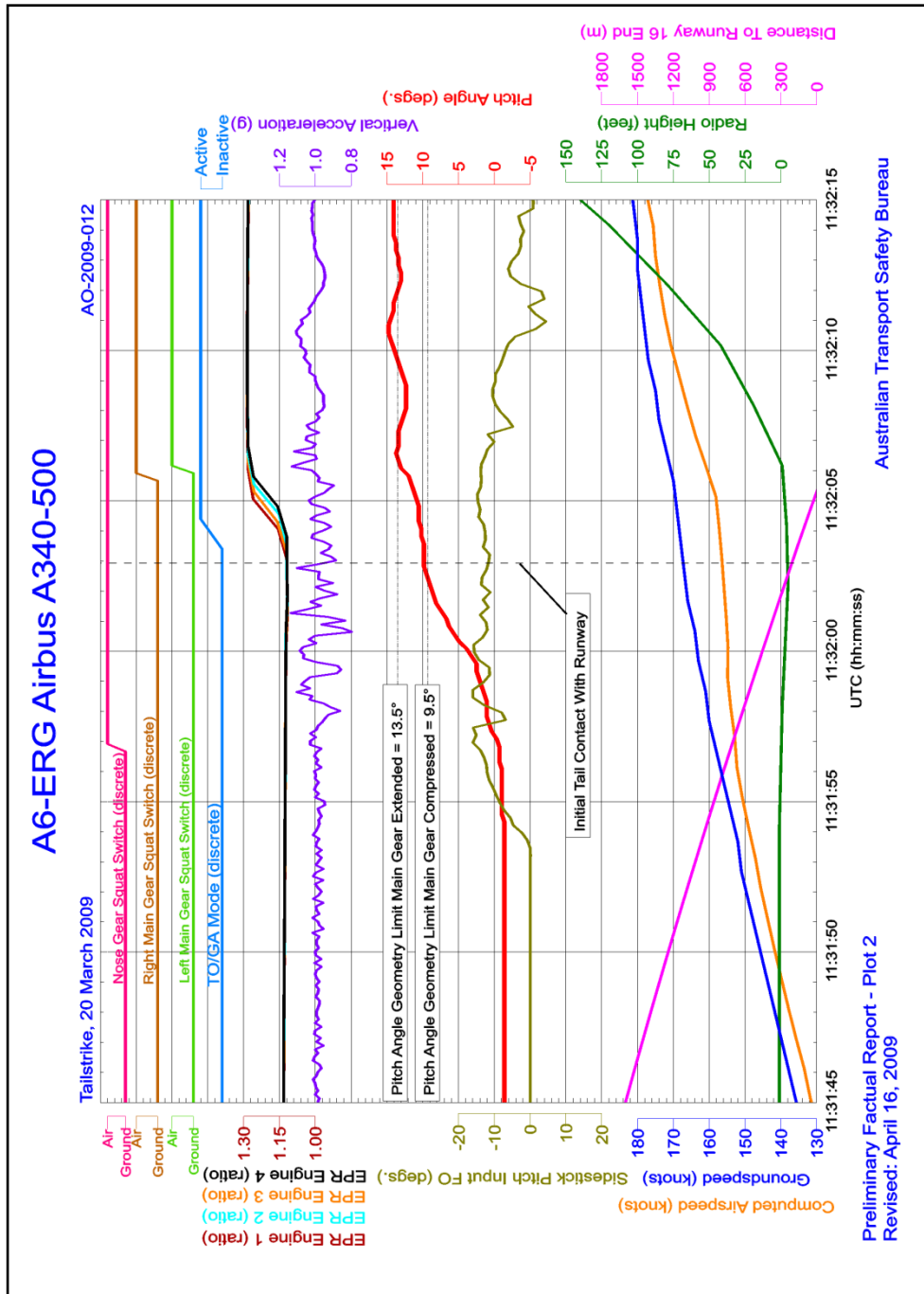

Figure A2: Selected DAR parameters for 30 seconds either side of the takeoff



APPENDIX B: KEY EVENT SNAPSHOTS

Figure B1: Aircraft attains computed airspeed of 143 kts corresponding to the V_1 used by the crew during the takeoff



Figure B2: Initial tail contact with the runway



Figure B3: Final tail ground contact witness mark

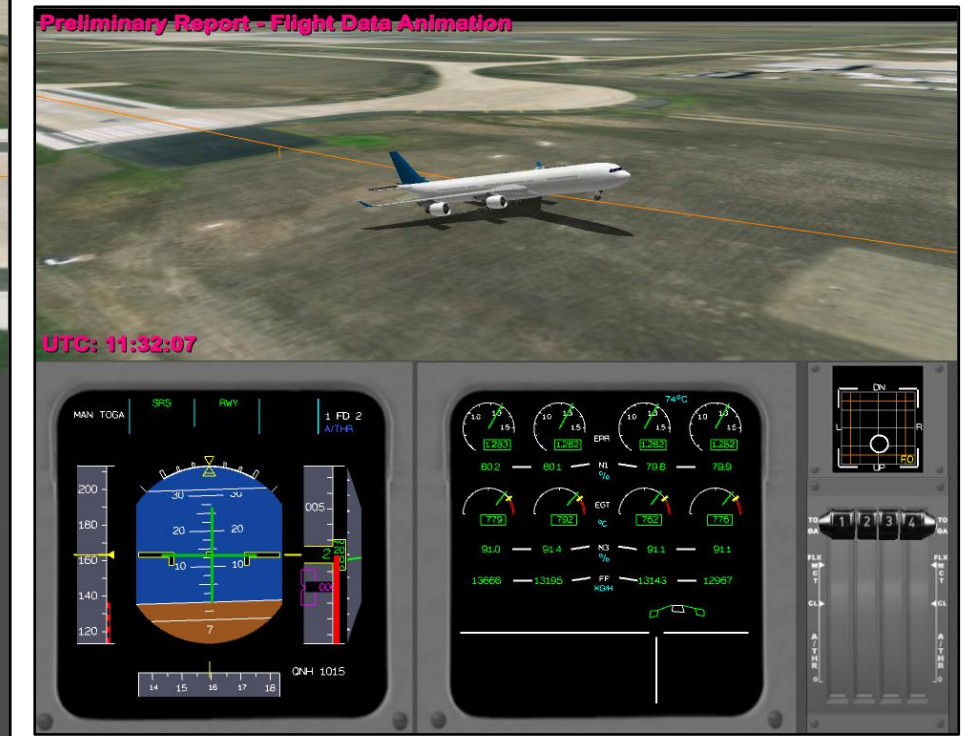
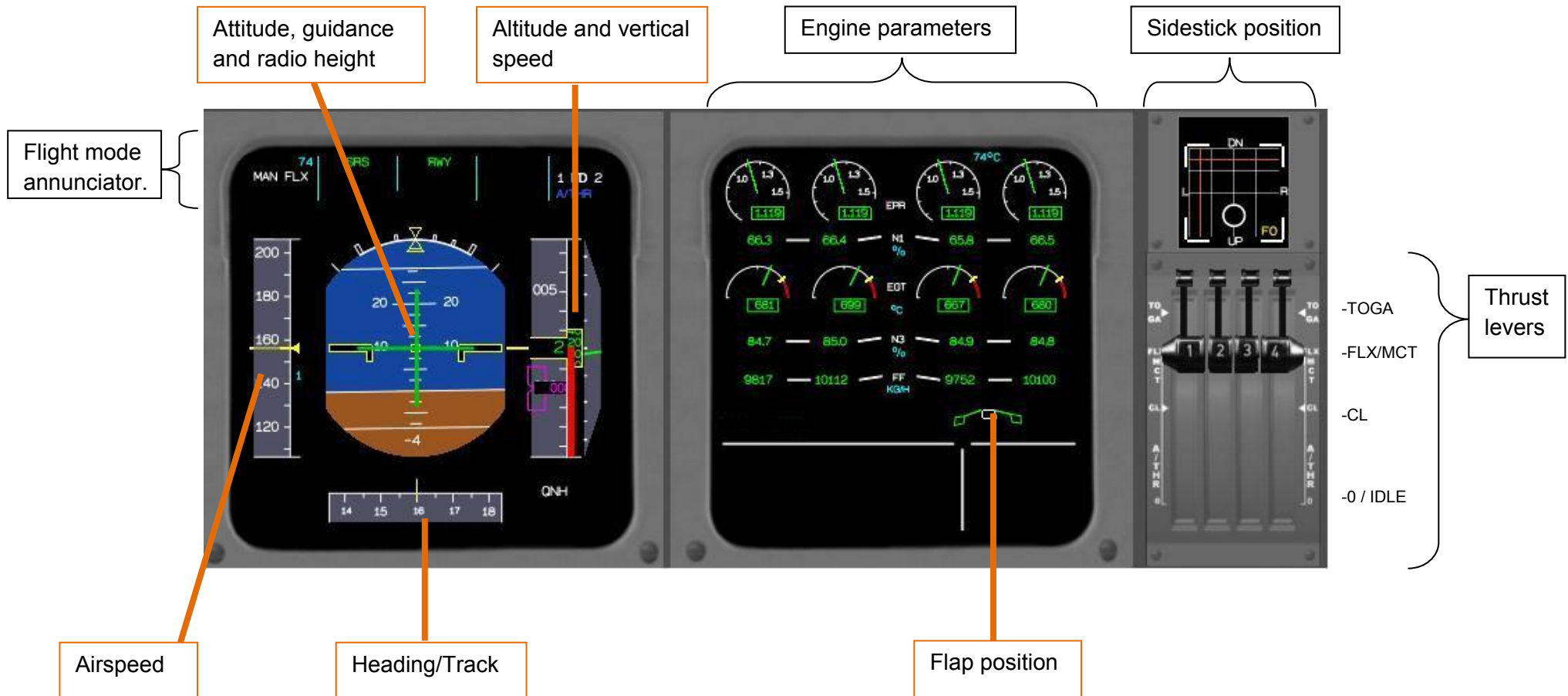

Figure B4: Graphical representation of the DAR data showing the position of the aircraft at a computed airspeed corresponding to V_1 as used by the crew, initial tail contact with ground, and final tail ground contact witness mark.

Figure B5: Diagram depicting the parameters as displayed on Figures B1 to B3



APPENDIX C: AIRBUS TAKE-OFF SECURING FUNCTION

The following pages contain an article from the July 2009 edition of the Airbus *Safety First* magazine, announcing the Take-off Securing function.



The Take-Off Securing function

1 Introduction

The utilization of erroneous parameters, during the flight preparation, have resulted in tail strikes, high speed rejected take-offs and runway overruns.

This triggered the elaboration by Airbus of pack one of the Take-Off Securing function (TOS), which automatically checks the entered data for consistency.

The second pack, currently under development, will offer more safety enhancing functionalities. One of them is the real time Runway length / Remaining distance on runway function, whose objective is to reduce the probability of take-off runway excursions.

This article is a presentation of both packs of this new safety enhancing function.

2 Possible errors and their consequences

The take-off preparation by the pilots entails the computation of the aircraft weights (Zero Fuel Weight, Take-Off Weight) and respective CG positions, as well as the calculation of the different Take-Off speeds (V_1 , V_R , V_2) and thrust rating.

These data may be obtained either by using load sheets and take-off charts, or by means of non-aircraft software applications (i.e. flight operations laptops).

Three types of errors may be performed during this process:

- Parameters entered into the tables or into the programs may be wrong (carried load, outside temperature, runway length etc...)
- Computations may be inaccurate (wrong interpretation of charts, bug in the software etc...)
- The data entry process into the Flight Management System (FMS) may be incorrect (distraction, stress etc...).



Figure 1: Minimum Unstick Speed (VMU) determination during flight test

Each of these types of errors may have consequences on the Take-Off speeds:

- A too low V_R inserted through the Multipurpose Control & Display Unit (MCDU), may lead to a tail strike
- A too low V_2 may lead to the flight path not clearing the obstacles in an one engine out condition
- A set of too high Take-Off speeds may lead to a runway overrun or too high energy rejected take-off (RTO).

Other possible consequences:

- An error on the A/C configuration at take-off (CONF/TRIM setting) may lead to an “auto rotation” or a nose heavy condition
- A take-off from a different runway from the intended one, or even from a taxiway, may lead to:
 - A collision on ground with another aircraft, vehicle or obstacle
 - A collision in the air with an obstacle
 - An overrun if no lift-off before the end of the runway (even more so if combined with a high temperature FLEX take-off)
 - A low or high energy runaway overrun (in case of RTO)
- A wrong thrust rating may result in a tailstrike, a runway overrun or a shift of the climb path.

3 | Description of the Take-Off Securing function (TOS)

The TOS has been developed to detect, to the best extend possible, wrong data entered into the FMS.

The aim of the function is to perform consistency checks between several take-off parameters.

The function is composed of two packages of modifications:

- The first one, TOS pack 1, is already implemented on the A320 family (except the PITCH TRIM / MCDU / CG disagree alert), and is under development for the A330/A340 and A380 (target 2011).
- For the A320 family, TOS pack 1 will be updated to include the PITCH TRIM / MCDU / CG disagree alert that already exists on the A330/A340 and A380
- The second package, TOS pack 2, is under development for the A350 and will later be applied on the A380.



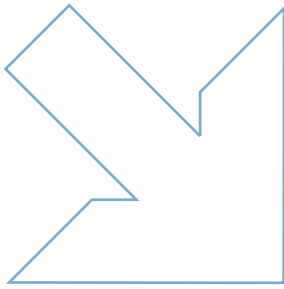

3.1 TOS pack 1

The first Take-Off Securing package is implemented on the A320 family of aircraft equipped with FMS release 1A.

The Thales system checks:

- The Zero Fuel Weight (ZFW) range
- The Take-Off speeds consistency.

The Honeywell system checks:

- The Zero Fuel Weight (ZFW) range
- The Take-Off speeds consistency
- The Take-Off speeds limitations.

3.1.1 Zero Fuel Weight range

As soon as a ZFW value is entered, a range check is performed:



$$ZFW_{MIN} \leq 140.0 \leq ZFW_{MAX}$$

The ZFW entry is rejected and an “**ENTRY OUT OF RANGE**” caution message appears on the MCDU scratchpad when the check is not fulfilled.



Figure 2: MCDU scratchpad message for ZFW range check

Note: The previous very broad range check has been refined, under TOS pack 1, to be more relevant to each aircraft type.

3.1.2. Take-Off speeds consistency

This check is performed as soon as all Take-Off speeds are inserted in the PERF take-off page, or each time a take-off speed is modified.

A “**V1/VR/V2 DISAGREE**” caution message will appear on the MCDU scratchpad when the following condition is not fulfilled:

$$V_1 \leq V_R \leq V_2$$

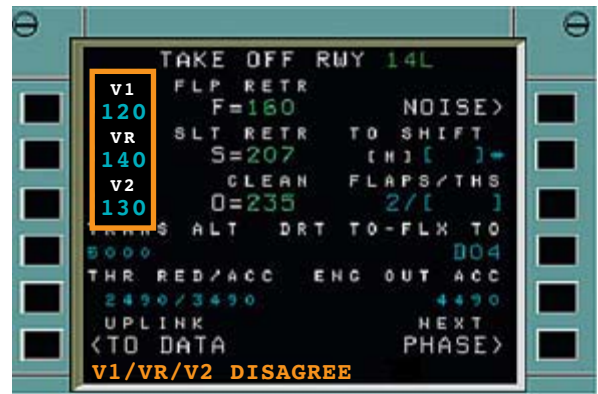

Figure 3: MCDU scratchpad message for TO speeds consistency check

3.1.3 Take-Off speeds limitations

V_{MC} and V_{S1G} limitations checks are launched when:

- ZFW, BLOCK and CONF are entered on the MCDU
- ZFW, BLOCK, CONF or take-off thrust setting are modified
- Engines are started.

V_{MC} limitation check:

$$\begin{aligned} V_1 &\geq V_{MCG} \\ V_R &\geq 1.05 V_{MCA} \\ V_2 &\geq 1.10 V_{MCA} \end{aligned}$$

V_{S1G} limitation check:

$$\begin{aligned} V_R &\geq K_{VR} * V_{S1G} \\ V_2 &\geq K_{V2} * V_{S1G} \end{aligned}$$

(K_{VR} and K_{V2} are margin coefficients)

Minimum values are derived from V_{MC} and V_{S1G} and computations are based on pilot entered take-off data.

In case of an abnormal TO speed, the “**TO DATA/TOW DISAGREE**” caution message appears on the MCDU scratchpad.

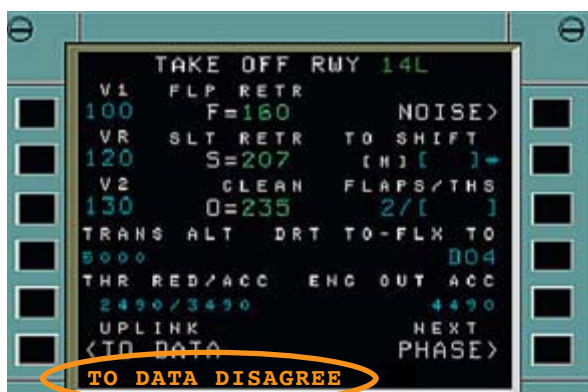

Figure 4: MCDU scratchpad message for TO speeds limitations check

3.1.4 PITCH TRIM / MCDU / CG disagree alert (for A320 family)

This check is performed when the TO Config Push Button is pressed, and during flight phase 3.

The following three parameters are checked for consistency:

- The Trimmable Horizontal Stabilizer (THS) setting (TRIM) entered in the FMS
- The theoretical TRIM calculated from the CG by the Flight Augmentation Computer (FAC)
- The real position of the TRIM from flight controls.

When one of these parameters differs from the two others by more than 1.3° of THS, the **PITCH TRIM / MCDU / CG DISAGREE** caution is displayed on the ECAM and a single chime aural alert is triggered.

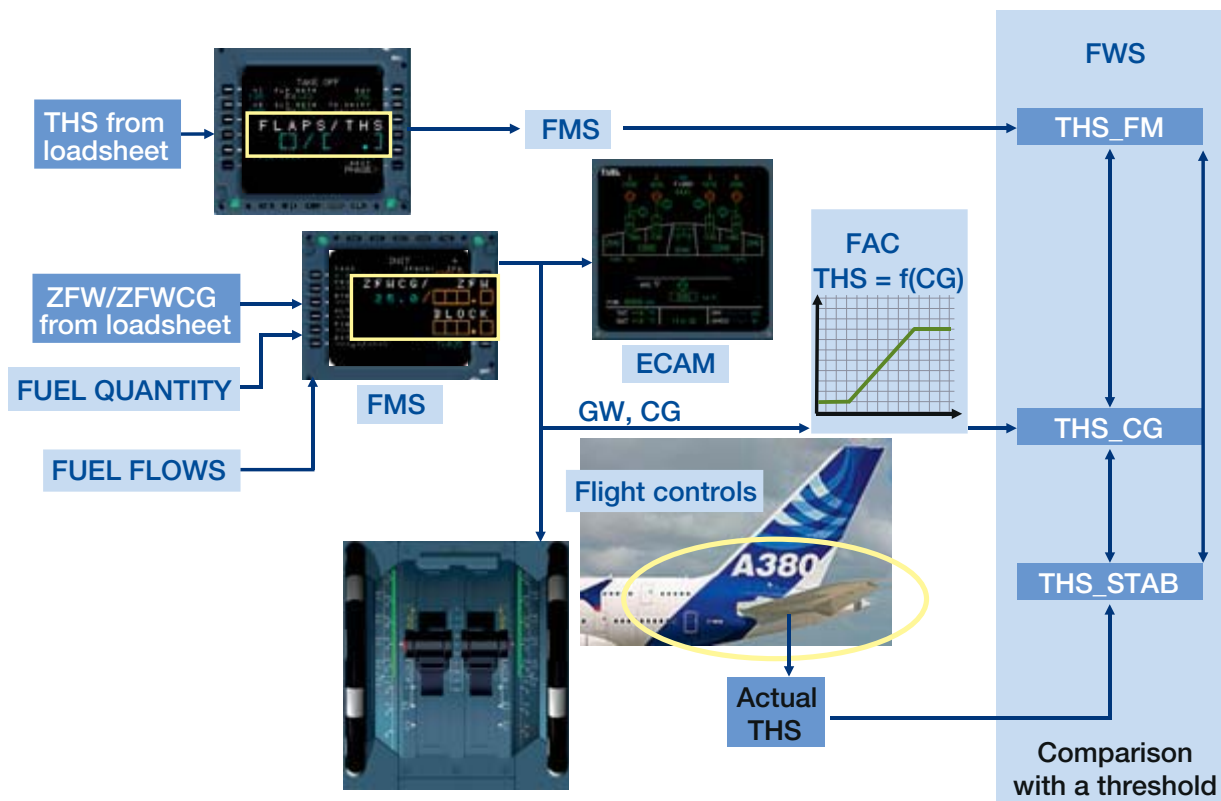
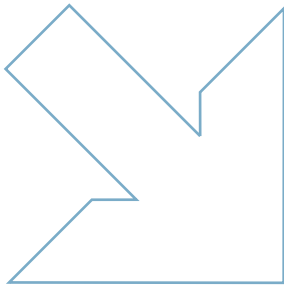

Figure 5: PITCH TRIM / MCDU / CG disagree check schematic



Summary of TOS pack 1 checks:

CHECKS	Risks covered	Implementation
TO speeds consistency	Inversion between two speeds and gross erroneous input of one TO speed	FMS release 1A THALES and HONEYWELL
ZFW refined range	Gross erroneous ZFW input in the FMS	
V_{S1G}/V_{MU} limitation ($V_2 > V_{2min}$ and $V_R > V_{Rmin}$)	Erroneous input of too low V_2 and V_R in FMS and inconsistency between TO weight/CONF/THRUST and V_2/V_R for any weight. TO performances computation with erroneous parameters	FMS release 1A HONEYWELL
V_{MC} limitation ($V_1 > V_{1min}$, $V_2 > V_{2min}$ and $V_R > V_{Rmin}$)	Erroneous input of a too low TO speed in FMS (taking into account thrust rating)	
PITCH TRIM / MCDU / CG DISAGREE alert on 320 family	Incorrect TRIM setting, Auto rotation, nose heavy	EIS S9.0, FAC 621 and FWS H2 F6 standards

Note:

V_{MU} minimum unstick speed, is the calibrated airspeed at and above which the aeroplane can safely lift off the ground, and continue the take-off.

V_{MCG} minimum control speed on the ground. It is the calibrated airspeed during the take-off run, at which (when the critical engine is suddenly made inoperative) it is possible to minimize the deviation of the airplane by the use of the primary aerodynamic controls alone, to enable the take-off to be safely continued using normal piloting skill.

V_{MCA} minimum control speed in the air. It is the calibrated airspeed at which, when the critical engine is suddenly made inoperative, it is possible to minimize deviation of the airplane with that engine still inoperative, and maintain straight flight with an angle of bank of not more than 5 degrees.

V_{S1G} speed that corresponds to the maximum lift coefficient (i.e. just before the lift starts decreasing).

3.3 TOS pack 2

TOS pack 2 will offer a more complete safety net against erroneous take-off parameters entered in the FMS. It will supplement the protection offered by TOS pack 1.

TOS pack 2 will offer the following additional checks:

- Take-Off speeds availability
- Runway limitation and remaining runway length
- Aircraft position on runway
- FLEX temperature setting.

3.3.1 Take-Off speeds availability

The objective is to avoid a take-off without Take-Off (TO) speeds (due to a last minute change, for example).

The system checks that the TO speeds have been inserted during the flight preparation.

It is launched when the crew checks the aircraft configuration before take-off.

It is relaunched automatically at take-off power application.

If the TO speeds are not available, the TO CONFIG test will be invalidated. This will trigger a **“NO FMS TO SPEEDS”** caution message on the ECAM and a single chime aural alert.

3.3.2 Runway length / Remaining distance on runway

The objective is to reduce the probability of runway overruns.

To achieve this, the system performs the following:

- During the pre-flight phase, the system checks that the inserted TO data are consistent with the planned departure runway. The estimated lift-off run distance is compared with the distance available on the runway (including TO shift)
- During the take-off phase, the system compares the estimated lift-off run distance with the remaining distance on the runway, taking into account the real time position and speed of the aircraft.

If the system detects a risk of runway overrun during the pre-flight phase, a caution message is displayed on both the MCDU scratchpad and the ECAM.



Figure 6: MCDU scratchpad message for runway limitation check (MCDU)



Figure 7: MCDU scratchpad message for runway limitation check (MFD)



Figure 8: ECAM alarm when the Lift-off run check detects a risk of overrun at take-off (take-off power condition is false)

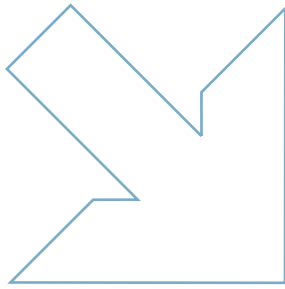

If the system detects a risk of runway overrun during the take-off phase (thrust levers set in a position higher than the Climb (CLB) detent), a **“RWY TOO SHORT”** warning is displayed on the ECAM and a single chime aural alert is triggered.



Figure 9: ECAM alarm when the Lift-off Run check detects a risk of overrun at take-off (take-off power condition is true)

3.3.3 Aircraft position on airport

The objective is to prevent a take-off from:

- A taxiway
- A wrong runway.

As soon as the thrust levers are set in a position higher than the CLB detent, the system compares the position of the aircraft with the FMS navigation database.

If the aircraft is not on a runway, an **“ON TAXIWAY”** warning is displayed on the Navigation Display (ND) (all the ranges are concerned) and an “ON TAXIWAY!” specific aural alert is triggered.



Figure 10: ON TAXIWAY message on ND.

If the aircraft is not on the runway selected by the pilot, a **“NOT ON FMS RWY”** caution message is displayed on the ND (all the range are concerned) and a “NOT ON FMS RWY!” aural alert is triggered.

3.3.4 Take-off FLEX temperature setting

The objective is to check the FLEX temperature setting upon selection of FLEX take-off.

On current aircraft, when the thrust levers are set on the MCT/FLX detent, the FADEC compares the entered FLEX setting with the outside temperature. In case of incompatibility, the **“ENG THR LEVERS NOT SET”** caution, as well as the procedure to follow, are displayed on the ECAM and a single chime aural alert is triggered.

In the frame of TOS2, the above ECAM caution message will be changed to indicate **“SAT ABOVE FLX TEMP”**.

4 | Conclusion

The Take-Off Securing function performs automatic consistency checks between several take-off parameters.

The function is composed of two packs for FMS inputs consolidation:

- The first one, TOS pack 1, is already implemented on the A320 family (except the PITCH TRIM / MCDU / CG disagree alert) and is under development (target 2011) for the A330/A340 and A380. For the A320 family, TOS pack 1 will be updated to include the PITCH TRIM / MCDU / CG disagree alert that already exists on the A330/A340 and A380.
- The second package, TOS pack 2, is under development for the A350 and will later be applied on the A380.

The TOS function represents a safety net against erroneous take-off parameters, and is expected to reduce the number of experienced tail strikes, runway overruns and loss of control during take-off.

Two more packs are under study, which will be dedicated respectively to the take-off monitoring and weight & CG estimations.

APPENDIX D: MEDIA RELEASE

Tailstrike at Melbourne Airport, Vic. on 20 March 2009 – Interim Factual report

The Australian Transport Safety Bureau (ATSB) is releasing its Interim Factual report into the tailstrike involving Airbus A340-500 aircraft, registered A6-ERG, during takeoff at Melbourne Airport, Vic. on the evening of 20 March 2009. The aircraft was being operated on a scheduled passenger flight from Melbourne to Dubai in the United Arab Emirates. This report builds on the facts advised in the report that was released on 30 April 2009 (ISBN 978-1-921602-43-6, available at www.atsb.gov.au).

The investigation has determined that the pre-flight take-off performance calculations were based on an incorrect take-off weight that was inadvertently entered into the aircraft's portable flight planning computer by the flight crew. Subsequent crosschecks did not detect the incorrect entry and its effect on performance planning, and the resulting take-off speeds and engine thrust settings that were applied by the crew were insufficient for a normal takeoff.

As a result of this accident, the aircraft operator has undertaken a number of procedural, training and technical initiatives across its fleet and operations; with a view to minimising the risk of a recurrence. In addition, the aircraft manufacturer has released a modified version of its cockpit performance-planning tool and is developing a software package that automatically checks the consistency of the flight data being entered into the aircraft's flight computers by flight crews.

The investigation has found a number of similar take-off performance-related incidents and accidents across a range of aircraft types, locations and operators around the world. As a result, the ATSB has initiated a safety research project to collate those events and examine the factors involved. The findings of that project will be released by the ATSB once completed.

The ATSB continues to work closely with the United Arab Emirates General Civil Aviation Authority (GCAA), the French Bureau d'Enquetes et d'Analyses (BEA), the operator and aircraft manufacturer. Ongoing investigation effort will include the examination of:

- computer-based flight performance planning
- human performance and organisational risk controls
- reduced thrust takeoffs and the use of erroneous take-off performance data.

The remainder of the investigation is likely to take some months. However, should any critical safety issues emerge that require urgent attention, the ATSB will immediately bring such issues to the attention of the relevant authorities who are best placed to take prompt action to address those issues. In the interim, the ATSB has drawn this interim report to the attention of operators to remind them of the risks associated with calculating and entering take-off performance information.

Media Contact: 1800 020 616